



INSTITUTE FOR WATER AND ENERGY SCIENCES

Master Dissertation

Submitted in partial fulfillment of the requirements for the Master degree
in

WATER POLICY

Presented by:

NATHAN OUMA MAJWA

**AN EVALUATION OF IMPACTS AND SUSTAINABILITY OF
HUMANITARIAN ORGANIZATION'S WATER PROJECTS IN JUBA, SOUTH
SUDAN**

Defended on 04/09/2018 Before the Following Committee:

Chair	Prof. Mustapha Benmouna	University of Tlemcen
Supervisor	Prof. Bolaji Sule Abs	University of Ilorin
External Examiner	Prof. Ghenim Abderrahmane	University of Tlemcen
Internal Examiner	Prof. Chewki Ziani-Cherif	University of Tlemcen

DECLARATION

I hereby declare that this research project is my original work and has not been presented as a Master degree thesis in any other university.

Signature:

Date : **09th Aug 2018**

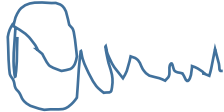

Nathan Ouma Majwa

SUPERVISOR

This project research has been submitted with our approval as the university supervisors.

Signature :



Date: **10th Aug 2018**

Prof. Bolaji Abdulfatai Sule

Pan African University Institute of Water and Energy Sciences

Master Thesis COORDINATOR

Signed..... Date

DEDICATION

This project is dedicated to my Dad; Melkizadek Majwa and all my Siblings; Philemon Omondi, Ezekiel Otieno, Joshua Odhiambo, Loice Atieno, Nashon Oluoch and to my best friend Vera Kemunto. Thank you for your steadfast love, advice, encouragement, prayers and moral support throughout my study life. May you live to see the fruits of your hard work.

ACKNOWLEDGEMENTS

I want to thank everyone who contributed to the success of this project. I would like to acknowledge the tremendous guidance, suggestions and support that my supervisor Prof. Bolaji Abdulfatai Sule offered during my research work and preparation of the manuscript.

Further acknowledgement goes to the Oxfam family especially the Urban WASH department for the assistance offered during data collection and site visits. Special thanks go to my assistance supervisor, Mariana Motoso, for the guidance and advice that facilitate the smooth running of the data collection process.

Many thanks to all the PAUWES community for the support granted including the grant from African Union. I am infinitely thankful to my parents, brothers, sister and friends; Vera Kemunto, George Gudah, Felix Kasiti, Brian Wamukhoya and Daniel Wekesa, for their love and support throughout my academic life. My classmates for their friendship and assistance during my university life.

God bless you all.

TABLE OF CONTENTS

DECLARATION.....	i
DEDICATION.....	ii
ACKNOWLEDGEMENTS	iii
LIST OF ABBREVIATIONS	viii
LIST OF FIGURES	ix
LIST OF TABLES	xi
ABSTRACT	1
CHAPTER ONE: INTRODUCTION	2
1.0 Background	2
1.2 Statement of Problem	4
1.3 Justification of the Study	4
1.4 Aim and Objectives.....	5
1.4.1 Specific Objectives	5
1.4.2 Research Questions	5
1.5 Research Hypotheses	5
1.6 Conceptual Framework.....	6
CHAPTER TWO: LITERATURE REVIEW.....	7
2.1 Global, Regional and South Sudan Water and Sanitation Situation	7
2.2 South Sudan and SDGs	9
2.3 Women and Water supply.....	11
2.4 Water supply and Education	13

2.5 Water supply and Waterborne Diseases	14
2.6 Water Quality Parameters.	16
2.6.1 Turbidity	16
2.6.2 Solids	16
2.6.3 Temperature	17
2.6.4 pH	17
2.6.5 Odor and Taste.....	18
2.7 Conventional Water Treatment Plant	18
2.7.1 Coagulation and Flocculation	19
2.7.2 Sedimentation.....	20
2.7.3 Screening & Filtration.....	20
2.7.4 Chemical Treatment	20
2.8 Methods of Impact Analysis.....	21
CHAPTER THREE: METHODOLOGY	23
3.1 Introduction.....	23
3.2 Description of the Study Area.....	23
3.3 Methodology	24
3.3.1 Data Collection Methods and Instruments.....	24
3.3.2 Sampling Strategy	24
Data Collection Framework.....	26
3.3.3 Data collection	27

3.3.4	Data Analysis	28
3.3.5	Frequency distributions and graphical displays	28
3.3.6	Summary Statistics	28
3.3.7	Analyzing relationships between two variables	28
3.3.8	Testing of the Research Hypotheses	28
CHAPTER FOUR: RESULTS AND DISCUSSION		30
4.1	Private Water Sector Supply.	30
4.2	Objective One: Characterize WASH Projects done by Oxfam in Juba	32
4.2.1	Water Supply Infrastructure in Gumbo area	32
4.2.2	The Kor Williams South Solarized Borehole	34
4.2.3	The Gumbo Treatment Plant.....	35
4.3	Objective two: Impacts.....	41
4.3.1	Demographics of the respondents.....	42
4.3.2	Household Water Supply	43
4.3.3	Sanitation	48
4.3.4	Impacts on Waterborne diseases	49
4.3.5	Impacts on Education	52
4.3.6	Impacts on Women Empowerment and Leadership	57
4.4	Objective Three: Sustainability	61
4.5.2	Effect of Oxfam water projects on Education for Girls in Juba	65
4.5.3	Effect of Oxfam Water Projects on Women Empowerment in Juba..	67

CHAPTER FIVE: CONCLUSION AND RECOMMENDATIONS	70
5.1 Conclusion	70
5.2 Challenges and Recommendations	71
5.2.1 Challenges	71
5.2.2 Recommendations	72
References	74
Appendices:	78
Appendix I: Household (HH) Survey Questionnaire.....	78
Appendix II: Questions for Sustainability (For WMC)- FGD.....	84
Appendix III: FGD for Women.....	84
Appendix IV: Health Centre Questionnaire.....	85
Appendix V: School Teachers Questionnaire	87

LIST OF ABBREVIATIONS

NGO – Non-Governmental Organization

JMP – Joint Monitoring Program

AFBD- Africa Development Bank

SGD- Sustainable Development Goals

MDG- Millennium Development Goal

UNDP- United Nations Development Program

SHHS - Sudan Household Health Survey

GSS- Government of South Sudan

NTU- Nephelometric Turbidity Units

pH- Potential of Hydrogen

WHO- World Health Organization

UNESCO – United Nations Educational, Science and Cultural Organization

UNICEF – United Nations Children’s Fund

WMC- Water Management Committee

SPPS-Statistical Package for Social Sciences

WASH- Water Sanitation and Hygiene

NWERO- National Women Empowerment & Rehabilitation Organization.

NSDO- National Standards Development Organization

UKaid United Kingdom Aid for International Development

SSDP- South Sudan Development Plan

NBS- National Bureau Of Statistics

WHO – World Health Organization

LIST OF FIGURES

Fig.2.1 Global and regional drinking water coverage, 2015 (Source JMP: (2017)).....	7
Fig 2.2: Showing percentage of households who had access to improved sources of drinking water by state and by year.....	10
Fig. 2.3: Showing percentage of population with access to improved sanitation by state and by year.....	11
Figure 2.4 A conventional water treatment plant treating surface water.....	19
FIGURE 3.1; Map of the study area.....	23
Figure 4.1 Showing bicycle vendors supplying water sin Gumbo.....	31
Figure 4.2: showing water truck used for supplying water in Juba.....	31
Fig 4.3; Showing a borehole built by Oxfam in Khor Williang community.....	34
Fig 4.4. Showing the Gumbo treatment plant design.....	35
Figure 4.5. Showing the Filtration System.....	36
Figure 4.6: Plan view of the sedimentation tank.....	37
Figure 4.7 Another section of the treatment plant.....	38
Figure 4.8 Elevated Water Tank.....	39
Figure 4.9 Graph Showing the daily measurement for water quality parameters in the month of April 2018.....	40
Figure 4.10: Graph Showing the average values for water parameters for month on April 2018.....	41
Figure 4.11: A pie chart showing the sex of household interviewed.....	42
Figure 4.12: Distribution of age of respondents.....	42
Figure 4.13: Showing the number of people per household in Gumbo.....	43
Figure 4.14: Various sources of water for residents of Gumbo.....	44
Fig 4.15. Showing the various issues the households have with water.....	45
Figure 4.16 Picture showing Participants at a Chlorine sensitization session.....	45

Figure 4.17	Results of respondents on use of other sources of water	46
Figure 4.18	: The other sources of water used in Gumbo.	46
Figure 4.19:	Photo showing people getting water from the River.	47
Figure 4.20	Various methods used by households to treat water	48
Figure 4.21	Rates of handwashing after various activities	49
Figure 4.22	Respondents assessment of use of pit latrine in reducing water borne diseases	49
Figure 4.23	Rates of water borne diseases reported in Gumbo.....	50
Figure 4.24:	Graph showing the treatment methods used in the area.	50
Figure 4.25:	Causes of water borne diseases in Gumbo	51
Figure 4.26;	Provision of training on hygiene promotion	51
Figure 4.27	School attendance chart showing boys and girls in school.....	52
Figure 4.28	New school admission due to improved water to Gumbo.....	53
Figure 4.29	Admission and school attendance trends at Hossana Primary school	54
Figure 4.30	Showing school admission in Gumbo Christian School.	56
Figure 4.31	Leadership and management issues of the water scheme	57
Figure 4.32	Respondents understanding on control of the water scheme	58
Figure 4.33:	Structure of the Water Management Committee.....	58
Figure 4.34	Decision making at the water points	59
Figure 4.35	Number of women in management committee as claimed by respondents 59	
Figure 4.36	Various businesses started by women in Gumbo	60

LIST OF TABLES

Table 3.1 Shows A Typical Entry Sheet	27
Table 4.1 below shows all the water facilities in Gumbo area that were identified.	32
Table 4.2 Attendance record and class performance before and after WTP was provided at Gumbo by OXFAM	55
Table 4.3 Reason for lateness to school.....	55
Table 4.4 School Records in Gumbo Christian Primary School	56
4.5 Results on Hypothesis Testing	63
4.5.1 Effect of Oxfam water projects on water borne diseases prevalence among children in Juba	63
Table 4.6 Cross-tabulation between water borne diseases prevalence and access to water from Oxfam.....	63
Table 4.7 Chi-Square between water borne disease prevalence and access to water from Oxfam	64
Table 4.8 Correlation between water borne diseases prevalence and access to water from Oxfam	64

ABSTRACT

The civil war in South Sudan has affected the water supply infrastructure either completely destroying the water system or overstretching the system due to influx of the internally displaced persons. Many people are forced to use unsafe water sources such as the Nile River that passes through many states of South Sudan. Non-governmental organizations (NGOs) have moved to the region to provide the communities with safe water. One of such NGOs is Oxfam with a number of water projects and programmes in Juba, the capital of South Sudan. These include borehole drilling, construction of water treatment plant and training the community on proper sanitation and hygiene practices. Through household interviews, focused group discussions and participant observation, this study evaluated the impacts of Oxfam water projects in Juba with focus on the water treatment plant located in Gumbo, a district of Juba. Findings showed that there is a positive impact on the people in Gumbo in terms of eradication of waterborne diseases in children under the age of five years, girl child education and women empowerment. The hypothesis testing analysis results showed positive and significant linkage between the water treatment plant, education and women empowerment. The Fisher exact test revealed a significance level of $p=0.025$ on education and $p=0.005$ on women empowerment. There was also evidence of sustainability of the technology in use, financial sustainability and community training of the use of the facility. The findings also revealed the need for continuous funding of Non-governmental projects to increase safe water coverage and sanitation.

CHAPTER ONE: INTRODUCTION

1.0 Background

The public water supply for domestic use and drinking in Juba is limited. This has led to dynamic private sector supply water in Juba to fill the gap left by the public water supply in the city. This service is available at very high cost and the water delivered is always of low quality. Many people resort to the use of untreated swamp water and other unsafe water, which has led to an increase in water-borne diseases and has therefore increased the burden of household chores for women and girls, who have the role of caring for the sick and infirm. Furthermore, men and boys use the same facilities for water needs of their animals, which puts them in conflict with other men and boys as well as women and girls who share the water points. As in most parts of South Sudan, fetching water for household use and, at times, for animals, as well as caring for the sick and infirm is considered a primary role of women and girls.

Data from protection and gender assessment reports indicate that females tend to be vulnerable to Sexual and Gender Based Violence (SGBV) when they have to walk extremely long distances or walk in the dark due to the need for repeated trips to collect water. They are also prone to Sexual and Gender Based Violence when there are too few safe water points and when they are too far apart or to their households. Currently, women and girls are forced to long distances to the nearest safe water venue. In the dry season, they are also forced to collect water for animals as well. Poor access to water coupled with their household responsibilities and the possible conflicts and long waiting periods at water holes negatively impact on the daily household chores and unpaid workload and therefore reduces the amount of time women and girls have to spend on socio economic and other activities.

There has also been an increase in the cost of fuel and food stuff throughout the country since the 2016 conflict. Many businesses have closed down and delivery patterns of water and other basic commodities have changed. This has led to a reduction in household purchasing power. A research done by Oxfam in 2015 to assess the impact of deteriorating economic situation on the access to water supply found that the main supply of water in Juba had suffered significant operation costs. This forced the water tracks to increase their tariffs (Oxfam 2015).

Many Non-governmental organizations (NGO) have moved to South Sudan to help in the provision of relief food including water and non-foodstuff. Oxfam is a leading NGO in water provision in the country and has a number of water and sanitation related projects all over the country. In Juba, Oxfam has projects that are geared toward increasing water supply to the people of South Sudan. One of the main projects recently done is the building of a water treatment plant in Gumbo. The treatment plant has a capacity of 300 m³/day and is operated by the community. The water from this plant is accessed by households, bicycle vendors and tracks.

Several studies have been carried out on different aspects of rural water supply and sanitation programmes implemented by NGOs in South Sudan. Little academic studies have been done to assess the impact of water supply and sanitation programmes on livelihoods, except through midterm and end of term evaluations, where they measure impact in terms of number of facilities installed. Elsewhere in the world, impact studies have been done in water supply and sanitation, and have mostly focused on health, education, employment. They have also evaluated the sustainability of water supply and sanitation interventions. An example is Rauniyar (2011), who did a study on the impact of rural water supply and sanitation in Panjub, Pakistan. He studied the impacts of two water supply and sanitation projects in rural areas of Pakistan in improving access to sanitation and water supply and on education, health and labor supply. He did a household survey of 1300. The impact was estimated using a treatment effects based on a control-function approach. His findings showed that the projects improved households' access to water supply, improved attendance of high-school girls in schools, and reduces the drudgery associated with fetching water. The project however had no significant impact on the incidence and intensity of diarrhea and on increasing labor force participation and hours that were available for work.

This research was focused on an evaluation of the water treatment plant built by Oxfam in Gumbo. It placed emphasis on health of children under the age of five years, girl child education and women empowerment. The findings of the research will be useful to stakeholders including Oxfam. It will allow Oxfam to analyze the gaps and take advantage of opportunities for improvement in the water provision projects.

1.2 Statement of Problem

Due to the civil war in South Sudan, many families have been displaced and the water infrastructure that existed have either been over stretched or destroyed during the war. Many people are left with no option but to use the unsafe water sources that has led to many children under the age of five years dying from waterborne diseases. The displaced families have also moved far away from safe water sources and this has led to women and girls walking long distances to get to a water point. Those unable to walk for long distances have been left with no option but to use the unsafe water available near them.

The water sold by tankers are quite expensive due to economic situation in South Sudan and the poor prefer the unsafe water sources that are free. The main source of water in Juba town is the White Nile which is a transboundary water body. In an attempt to help the communities get safe water for drinking and for other domestic use, many humanitarian organizations have started several water projects in south Sudan. Oxfam is one of these humanitarian organizations. In Juba town, Oxfam has drilled boreholes around the town and have also built a water treatment plant in Gumbo. The solar powered plant provides safe water for over 40.000 people living in the area.

There is need to evaluate such projects to know how they have impacted the water supply to that community and also to know the sustainability of such a project. The evaluation will help Oxfam to further understand the performance of the project and the need for adjustments to improve water delivery to the community. It will also be useful in guiding the NGO when it is planning future water scheme in the region.

1.3 Justification of the Study

This study will evaluate the water projects done by Oxfam in Gumbo with focus to the water treatment plants located on the banks of River Nile. Household survey, focused group discussions and key interviews will be conducted in an attempt to establish a linkage between the water treatment plant, waterborne diseases prevalence, girl child education and women empowerment.

The findings of the study will be of help to Oxfam and other humanitarian organizations in developing strategies for providing safe water to communities in war zone areas. This will ensure that the water provided to these communities are of good quality and are compatible with the world standards for safe drinking water. The findings of this study will also be of

significance to donors who fund humanitarian water projects. The project will highlight the extent to which the water treatment plant project has impacted the Gumbo community when it comes to waterborne diseases reduction, women empowerment and girls' school attendance. It will also investigate whether there is significant reduction of the distance covered by women and girls in search of water. Humanitarian organizations will be able to know community perception on their water projects through feedback that will be obtained through questionnaires. The target group for this study comprised of women, girls and children under the age of five years.

1.4 Aim and Objectives

The main aim of this study was to evaluate the impacts and sustainability of Oxfam water projects in Juba, South Sudan.

1.4.1 Specific Objectives

- i. To review the state of public water supply system in Juba
- ii. To identify the role of private sector in water supply in Juba
- iii. To characterize the water supply projects done by Oxfam in South Sudan
- iv. To determine the impacts of the Gumbo water treatment plant at household level.
- v. To evaluate the sustainability of Gumbo water treatment plant.

1.4.2 Research Questions

- i. What are the water projects done by Oxfam in South Sudan?
- ii. What impact does Oxfam projects have on households in Juba, South Sudan?
- iii. How sustainable are the water projects done by Oxfam in Juba, South Sudan?

1.5 Research Hypotheses

The study sought to test the following null hypotheses;

H₀₁ Oxfam water projects does not significantly reduce water borne diseases in children under five years in Juba

H_{A1} Oxfam water projects significantly reduce waterborne diseases in children under five years in Juba

H₀₂ Oxfam water projects does not significantly improve education for girls in Juba

HA₂ Oxfam water projects significantly improve education for girls in Juba

H0₃ Oxfam water projects does not significantly improve women empowerment in Juba

HA₃ Oxfam water projects significantly improve women empowerment in Juba

The aim was to look for evidence of each of these categories of impacts and examine whether there is a clear linkage among the provision of improved access to clean water, impact and sustainability of the Gumbo water treatment plant.

1.6 Conceptual Framework

Independent Variable

- 
- Oxfam Water Projects
- Safe Water Provision
 - Sanitation
 - Hygiene awareness

Dependent Variable

- Community water Supply
- Safe water provision
 - Girl child education
 - Waterborne diseases prevalence in children under the age of five years
- Sustainability of water provision

CHAPTER TWO: LITERATURE REVIEW

This chapter reviews the literature on how development interventions like the provision of improved access to clean water to rural communities can lead to improvements in health, educational options for girls, women’s empowerment and community governance and participation. It also examines the methodology used in assessing the impacts with a view to determining their applicability as a tool in measuring the impact of clean water projects in Juba, South Sudan. The chapter also highlights the current water and sanitation situation in the world, Africa and South Sudan.

2.1 Global, Regional and South Sudan Water and Sanitation Situation

The world’s current population stands at 7.6 billion and it is estimated that 844 million people still lack basic drinking water services (WHO/UNICEF, 2017). The same report found out that 159 million people still collect drinking water directly from surface sources and about 58% are from Sub-Saharan Africa. In terms of sanitation access, there are more than 892 million people worldwide who are practicing open defecation. It is estimated that over 2.3 billion people still lack basic sanitation services. Figure 2.1 shows that only 24% of the population in Sub-Saharan Africa have safely managed water schemes while about 18% use unimproved water sources.

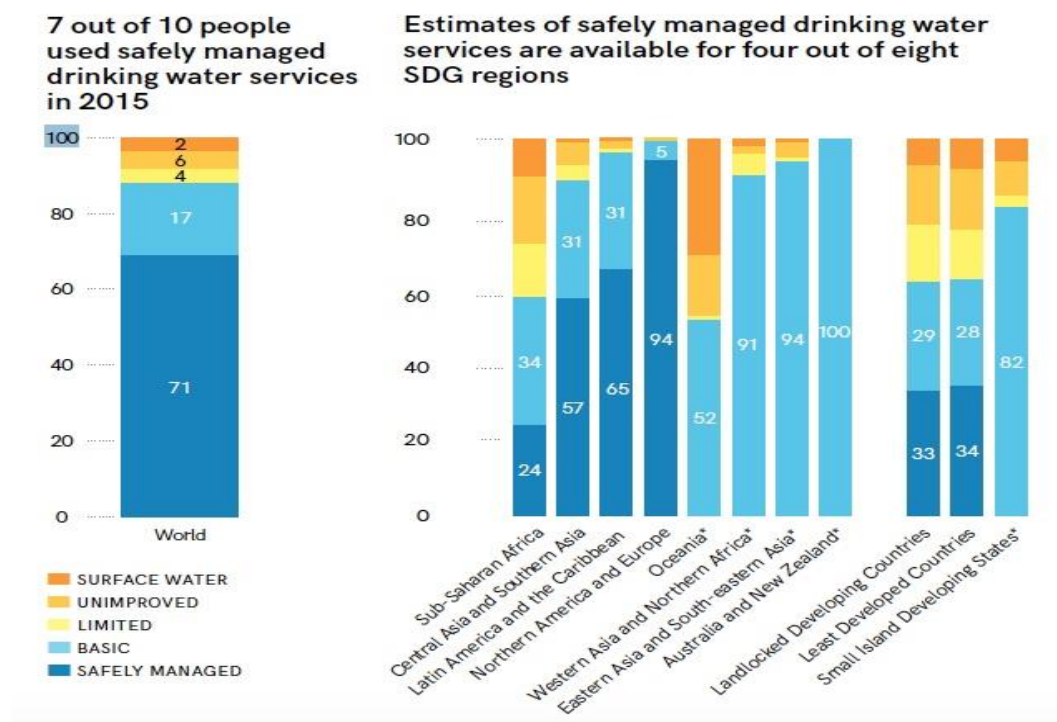

Fig.2.1 Global and regional drinking water coverage, 2015 (Source JMP: (2017))

In Africa, research has shown that most countries have high urban coverage for improved water sources including piped water. The other common sources including wells and surface water are mainly used as alternatives by close to 20% of the urban population mostly in eastern, central and western Africa. There are at least four factors that are influencing water and sanitation needs in Africa. The first two factors are the scale of a given urban area and the rate of expansion. The scale is important in that improvements in access are strongly driven by economies of scale with respect to provisions. This would mean it is cheaper to connect households with water or sanitation systems when there are other households that are already connected. The rate at which an area grows is equally important because expansion would pose challenges for urban planners (Kararach, Yepes 2017).

The issue of climate change is also taking shape in the African context and has affected water sources across the continent including lakes, river and streams. Unpredictable weather pattern coupled with decreased levels of water in the lakes are the order of the day. The last challenge is the losses in the water systems. This poses a threat to the scarce water resources that are there in Africa. Leakages and uncountable water all sum up to losses found in the water systems.

In East Africa where South Sudan is classified, the joint monitoring programme (JMP) of the World Health Organization and UNICEF has come up with estimates to show the current situation of water and sanitation. In Kenya for example, it is approximated that 80% of hospitals have attendance that are due to preventable diseases and about 50% of these illnesses are related to water, sanitation and hygiene situations. Coverage of sanitation has dropped from 49% to 43% in the recent years. 50% of Kenyans do not have adequate sanitation and another 50% of the rural population do not have access to toilet facilities (UNICEF Kenya, 2017).

There is an abundance of surface and ground water resources in South Sudan. The White Nile which is transboundary water resources pass through the country's capital, Juba. Despite this fact, millions of South Sudanese lack access to improved water supply and sanitation services. Recent studies show that two in every three people in South Sudan do not have access to improved sanitation services (AfBD, 2013). In addition, about 1000 schools representing over 50% of the total number of schools in the country do not have sanitation facilities and water supply.

The low coverage of improved water supply and sanitation services, in addition to poor hygiene awareness has been the principal cause of water related disease in South Sudan; including cholera, diarrheal and guinea worm. Weak institutional capacity, increase in number of returnees and internally displaced persons continue to exert great pressure on the feeble water supply and sanitation facilities. All these can be traced back to decades of conflict and war that has resulted to destruction of several water infrastructure facilities (AfBD, 2013).

2.2 South Sudan and SDGs

The sustainable development goals (SDGs), goal number six talks about clean water and sanitation. It states that by the year 2030, all persons on earth should have access to safe and affordable drinking water (UNDP, 2016). Given the fact that South Sudan is listed as one of the countries that did not attain the millennium Development Goals, (MDGs), it therefore calls for more efforts of increasing water supply and sanitation access. The MDG goal 7 target 10 was to halve by 2015 the proportion of people without sustainable access to safe drinking water and basic sanitation. According to the National Bureau of Statistics, only about 7.4% of households used improved sanitation and the challenges posted were lack of resources, inequitable promotion of improved sanitation facilities (GSS, 2011-2013). Figure 2.2 shows percentage of households in South Sudan on state basis with access to improved water sources. The data presented is for 2006 and 2010.

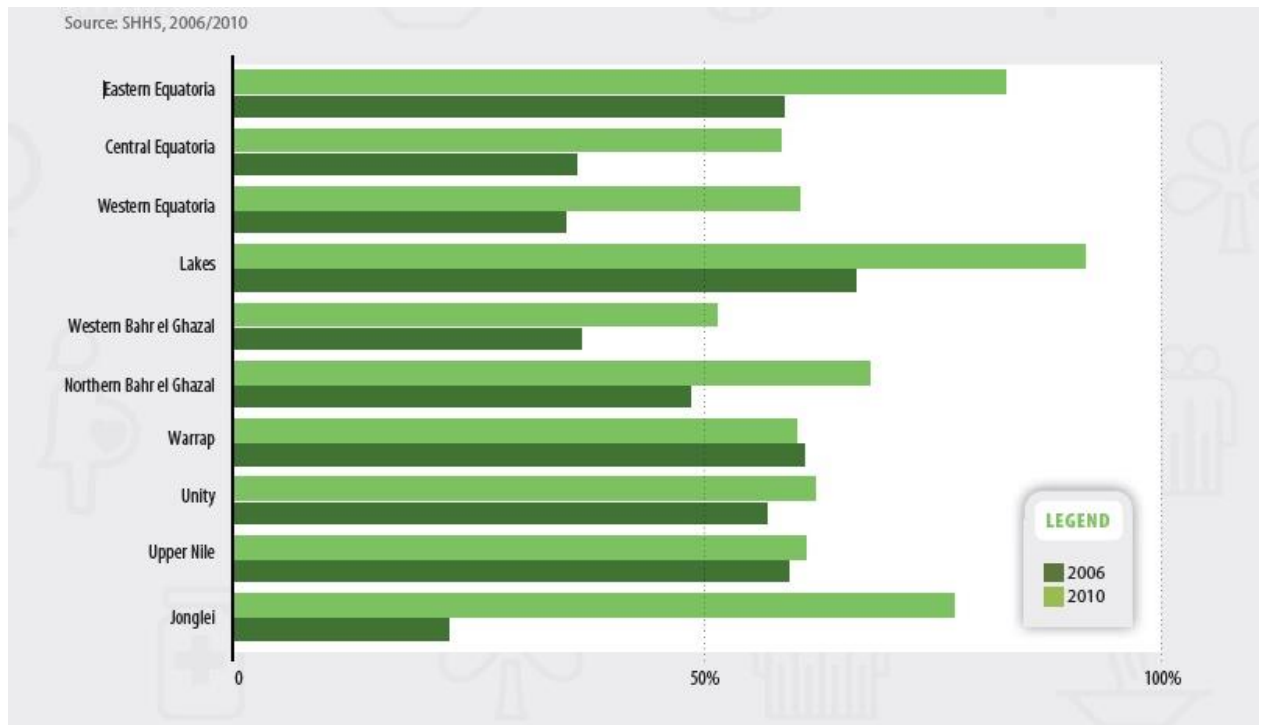

Fig 2.2: Showing percentage of households who had access to improved sources of drinking water by state and by year

The graph shows that there were improvements in access to improved drinking water sources with Bahr el Ghazal at 52% and Lakes at 92%. However, Warrap at 61% and Upper Nile at 61% had stagnated over the 4-year period from 2006 to 2010. In overall, statistics showed that 68% of people in South Sudan had access to improved source of drinking water. According to the report, in 2006, less than half (48%) had access to improved water sources for drinking. The survey done in 2010 indicated a 19% increase in access to improved sources of water for drinking purposes.

In term of sanitation, Figure 2.3 shows percentage of population with access to improved sanitation by state and by year. It can be seen that only about 7.4% of the households used improved sanitary means of excreta disposal.(SHHS, 2010) up from the 2006, 6.3% (SHHS 2006). The remainder of the population used either a pit latrine without a slab, or even the bush. According to the 2010 survey, 22% of the households in Western Equatorial were more likely to use a sanitary means of excreta disposal while was only 1% and 1.5% in Warrap and Northern Bahr el Ghazal states, respectively.

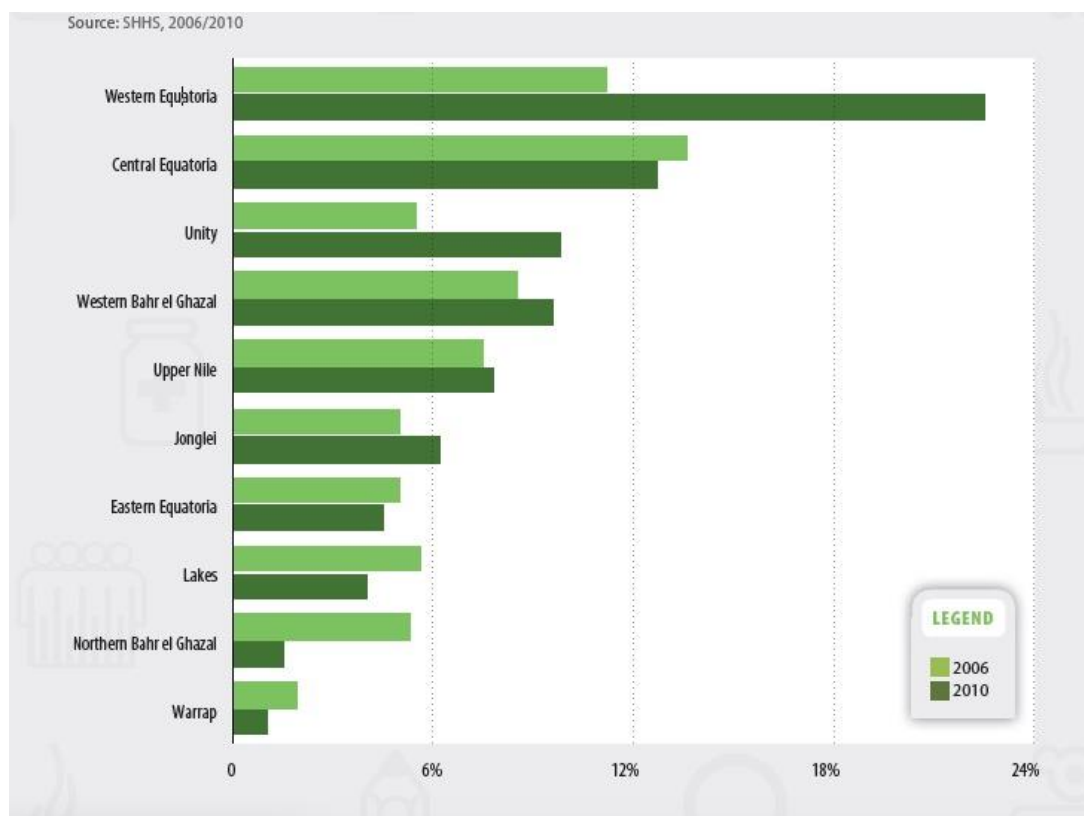

Fig. 2.3: Showing percentage of population with access to improved sanitation by state and by year.

2.3 Women and Water supply

In the developing world, women are by customary obligation take responsibility for domestic duties. This is based on the perception that women's main functions are reproduction, child care and homemaking. These expectations exist against the background belief that domestic realm is not of great importance. It is estimated that women in sub-Saharan Africa, spend close to four hours every day on water errands. Studies done in Mozambique, rural Senegal and eastern Uganda showed that women spend a between of 15-17 hours a week collecting water. This would increase in dry seasons when women walk up to 10 km in search of water. In eastern Uganda, it was found that households spend an average of 640 hours a year fetching water (UNDP 2006, 46)

Research shows that the times spend by women on fetching water are often at the expense of income generating activities or their leisure time. In India, for example, in the Gujarat region women who run microenterprises had to spend two hours per day at the expense of their businesses to take care of their household water needs in dry periods (Vimbayi, 2009)

There are cases in Uganda and Bangladesh where many women's main income generating activity was working as technicians and vendors of new water facilities. Other studies have shown that improving water supply enabled women to engage in other income generating activities including palm oil processing, pottery making and farming. This is in addition to more time dedicated for taking care of their young children and doing other household duties.

Aside the time lost by women as a result of the long hours of fetching water, there are other indications that this very phenomenon might be involved in relations to the low socioeconomic status of women. For instance, a study that was conducted among 200 women to determine the impacts of chronic water shortages in Ghana revealed a correlation between women's responsibilities as primary suppliers of household water and their health, income and educational status. The amount of time women spend fetching water during the times of severe scarcity always have negative effects on the income levels. The energy that women spend in fetching water had bad effects on their health. (Gross et al, 2018)

The study compared the impacts of the chronic water shortages on women who lived within the center of the metropolis and its outskirts. Women in the center settlement were generally better educated, more financially secured and more likely to have husbands who assisted in domestic duties than those living in the outskirts. Women in the center areas were better equipped to deal with severe water shortages than the women who lived in the outskirts. Customary obligations, poverty and low levels of education had made the women living in the outskirts to be more vulnerable to water shortages which in turn lead to a cycle of poverty and ill health. The author identified cultural influence as the main reason why husbands in the outskirts areas failed to help their wives with domestic duties. He also stated that this failure was as a result of the low social status of women within the urban outskirts and that it was a situation that mirrored the rural lifestyle of people in Ghana (Gross *et al*, 2018)

The study recommended that women were to be involved in planning and managing community water programs and also promoting female education as means to reduce the male dominating the household. The purpose was to reduce the big workload that the women had. The other also ironically recommend that women should be educated on better

water purification techniques. The irony comes in that the approach would further the perception that the water supply and related issues are sole responsibility of women. Efforts should be channeled towards education of the whole community emphasizing on the need for sharing domestic responsibilities (Gross *et al*, 2018)

Without access to clean drinking water and toilets, life is, strenuous challenging and dangerous for women and girls. This is true because of the following facts; the lack of private safe toilets and washing facilities for girls in schools is one of the main barriers keeping them from attending school especially during menstruation periods. If girls do not have a latrine in their home, they often wait until after dark to defecate in communal fields to have privacy. However, waiting all day can cause illness and discomfort. Security issues also arise when they have to travel to these fields at night. In many communities in Africa and in South Sudan particularly, women and girls are responsible for fetching water. The time it takes to transport sufficient water for the day is another barrier keeping girls from attending school or getting needed rest. Water-related illnesses are common in developing countries. When family members get sick, it is the women and girls who are expected to care for them. The objectives of water, sanitation and hygiene programming cannot be fully met without incorporation and full participation of women and girls. In many parts of the world, women and girls are traditionally responsible for fetching water, ensuring adequate sanitation and maintaining a hygienic home environment. Since they often manage the household, women have a greater interest in the improvement of water and sanitation facilities in the home. This is why it is particularly important to involve them in the roles of planning and management of water and sanitation programmes.

2.4 Water supply and Education

The absence of water and sanitation often impede children's education. Research by UNDP, shows that every year, 433 million school days are lost as a result of water and sanitation related diseases. In most of the cases, the effect that comes about with lack of clean water is trapping the children in a cycle of poverty. This is because lack of clean water always results to water related illnesses which results in lost in education and then followed by poverty in adulthood (Tay 2005; UNDP 2006). The health consequences due to inadequate clean water are well documented. However, the educational impacts that have been identified are related to the lengths of times spend by children hauling water from long distances and this leads them to missing out on school. Harvey (2008) identified

educational opportunities for girls as a major impact of improved access to clean water due to the fact that school attendance is increased as a result of reduction in time spent hauling water.

An evaluation of rural water projects in Nigeria, Morocco and India revealed that school attendance and enrollment rates for girls increased when their communities gained access to improved water. School attendance in five Moroccan provinces was reported to have increased by 20% over 4 years and this is attributed in part to lesser time spent fetching water while the amount of time spent on this task reduced by 50-90% (Gender and Water Alliance 2006).

2.5 Water supply and Waterborne Diseases

Diseases that are caused through direct drinking of contaminated water having pathogenic microorganisms are called water-borne diseases. When the same water is used in the preparation of food, it will cause food-borne diseases that contain the same microorganisms like in the water. A large number of waterborne diseases are always accompanied by diarrhea which results to dehydration and can sometimes cause death if not treated in time. The World Health Organization estimates that of all the diseases that occur each day, 4.1% are diarrheal in nature. Diarrhea also is responsible for an estimated 1.8 million deaths every year. 87% of the entire burden is pointed at unsafe water supply, hygiene and sanitation. This is mostly concentrated in children who come from developing countries.

Transmission route for waterborne diseases are many a times fecal-oral. This occurs when human fecal matter is ingested into the body through eating of contaminated food or drinking contaminated water. These contaminations always arise from poor sewage management and improper sanitation. Fecal pollution in water may be sporadic and the contamination may be low and fluctuate widely. In places where the contamination is low, the water supply may not carry life threatening risks and the community may have used the same source of water for a long time.

In places where the contamination is high, however, the communities living around the water source may have a higher risk of infection. This is more pronounced to visitors in the

area, the very young peoples and also the old people who are infected by immunodeficiency diseases.

In most parts of Africa especially the rural areas, fecal contamination of water always comes as a results of run off from the nearby bush or forest (which serves as defecation sites for rural inhabitants). The diseases can be caused by bacteria, protozoa, intestinal parasites and viruses. Some of the micro-organisms that are responsible for most outbreaks of waterborne diseases include; Bacillary dysentery (shigellosis), Amoebic dysentery, Cholera, Typhoid, Cryptosporidiosis, Salmonellosis, Leptospirosis, Hepatitis A, E.coli diarrhea and Rotavirus diarrhea.

Children under the age of five are the most vulnerable group to diarrheal infections. An estimated 1.8 million children die each year as a result of it. Repeated diarrheal infections before the age of five predisposes children to vitamin deficiency and malnutrition which puts them at even higher risk of contracting the disease and having it linger for longer times. Diarrhea further makes a child more prone to weight loss, stunted growth and vitamin deficiency (UNDP, 2006). The United Nations General Assembly in the 1980s declared the international drinking-water and sanitation decade. A research that was conducted in the following decade in the 90s, after a decade long drive towards improved water supply and sanitation, reported significant reduction in the water related diseases as a result of intervention projects that provided clean water and sanitation facilities to communities that lacked them.

Case studies in Peru, Mali and Lesotho revealed that health impacts are enhanced when access to clean water is complemented by improvements in personal and domestic hygiene and the exclusive use of improved water facilities. These communities were also likely to use new water systems if it was closer to them than the old water system.

Interviews that were conducted in Mali, showed that parents of children under seven years of age in villages that used various water sources showed that children who exclusively used water from an improved source had a lower diarrheal prevalence level than those who relied on a spring or stream.

The research recommended that water projects should incorporate education on the need for practicing good sanitation and also encourage attitude change so as to maximize their health benefits (Thakadu et al. 2018). The knowledge that different variables combine to determine if a water project generate good health benefits is not only necessary in the planning stage but also at the effective impact analysis.

2.6 Water Quality Parameters.

2.6.1 Turbidity

It's a measure of cloudiness of water-an expression of the optical property of water which causes light to be scattered and absorbed rather than transmitted in a straight line. The presence of colloidal solids gives water a cloudy appearance, which is aesthetically unattractive and may be harmful. Turbidity in water may be caused by micro-organisms or organic matter, silica or other mineral substances, zinc, iron, clay, asbestos fiber or other materials, as a result of discharge domestic sewage or industrial wastes.

Turbidity affects most uses of water. Turbidity decreases light penetration through water affecting plant photosynthesis and may also cause the water top warm up which may then lead to lowered oxygen concentrations (WHO, 2004). Turbidity may also clog the gills of aquatic animals. Also the settling of the particles in slower moving waters may bury some living things and attached aquatic organisms may be scoured from the rocks and sand. Readily turbid water is not acceptable to the public and if the water is highly turbid, treatment may be necessary. The international standard specifies the highest desirable level and maximum permissible level of turbidity in drinking water as 5 and 25 NTU (Nephelometric Turbidity Units) respectively. (Edition, 2011)

2.6.2 Solids

Solids may be present inform of suspensions and in solution form. They may be divided into organic and inorganic matter. Suspended solids are discrete particles which can be measured by filtering a sample through a filter paper. Settleable solids are those removed in a standard settling procedure. They are determined from the difference between suspended solid in the supernatants and the original suspended solid in the sample. Total dissolved solids are due to soluble materials. (Weber-Scannel & Duffy, 2007)

2.6.3 Temperature

Temperature of water at the users' end depends on the temperature of water at the source as well as the processes that the water has undergone by way of treatment and distribution. Industrial discharges of water mainly from power stations raise the temperature of receiving surface waters. The release of cold water from dams may affect the temperatures of stream water. It partially influences the off stream domestic users as well as in stream recreation. To a greater extent it determines the trends and tendencies of change in water quality. It affects the ion and phase equilibrium, rate of biological activity and biochemical process. As a result, changes occur in the concentration and content of organic and mineral substance in water. High temperatures stimulate the growth of planktons (Ndiongue *et al.*, 2005).

The solubility of gases is dependent on temperature. Increased temperature may sometimes increase the odor of water because of increased volatility of producing compounds. The desirable temperature of water for domestic uses especially for drinking is highly subjective and has local characteristics of good water (Edition, 2011).

2.6.4 pH

The intensity of alkalinity of a water sample is measured on a pH scale which actually measures the concentration of hydrogen ions present (Edition, 2011). Mathematically it is related to hydrogen ion concentration by the expression $\text{pH} = -\log [1/\text{H}^+]$, where $[\text{H}^+]$ is the hydrogen ion concentration. A water sample is considered to be acidic if it has a pH value of less than 7 and basic if greater than 7. The carbonate system is the principle system that regulates pH in natural waters.

The system is made up of carbon dioxide, carbonic acid, bicarbonate ion and carbonate ion. The relationship between the above four largely depends on the intensity of the process of photosynthesis and biochemical oxidation of some mineral substances. (Verma et al, 2012). Under natural conditions the pH in the surface waters range from 5 to 8.6 with exception of great range in some cases (UNESCO-WHO, 2004)

Coagulation for instance is very sensitive to pH because the efficiency of metal coagulants depends on the pH of water. Alum $\{\text{Al}_2(\text{SO}_4)_3 \cdot 18 \text{H}_2\text{O}\}$, is effective at a pH range of 5 to 7. Coagulation for removal of colloidal color by use of Aluminum or iron salts generally has an optimum pH range of 5 to 6.5 (Bratby, 2006). The efficiency of chlorine as a

disinfectant depends mainly on the equilibrium between hypochlorous acid and hypochlorite ion, $[\text{HOCl}=\text{H}^+ + \text{OCl}^-]$ a reaction which depends on the pH of water.

When pH is a little higher than 7, it suggests lots of photosynthesis occurring or significant presence of sea salts, while that lower than 7 suggests lots of aerobic respiration occurring, due to high carbon dioxide concentration in water, (Verma, *et al.*, 2012).

2.6.5 Odor and Taste

Objectionable odors are caused by the presence of any of a great variety of objectionable substances. They may be as a result of man's activities-such as from sewage and industrial waste products or they may come from natural sources such as microscopic organisms, decaying vegetation, and other organic matter. It's difficult to identify the specific cause of an odor because many substances may be involved. In order to detect the cause of an odor, a full knowledge of the source of water and methods of treatment used is necessary. For instance, some disinfectant such as chlorine may combine with phenol or organic matter to produce odor (Peter, 2008).

Odor producing materials sometimes impart taste to water. Taste and odor are the most difficult characteristics to measure in any numerical sense. Objection to taste and odor is subjective in nature and varies from person to person. The international standards have not specified the desirable levels of taste and odor because of its subjective nature. They only state that potable water should be unobjectionable in taste and odor (Srinivasan & Sorial, 2011).

2.7 Conventional Water Treatment Plant

A conventional water treatment plant has a number of processes that are able to remove contaminants of concern in water supply. These processes include; Coagulation, Flocculation, Sedimentation, Filtration and Chlorination (Figure 2.4). These processes are capable of removing pathogenic bacteria, suspended materials, colour, odour, taste, turbidity, hardness, synthetic organic compounds, inorganic constituents and total dissolved solids.

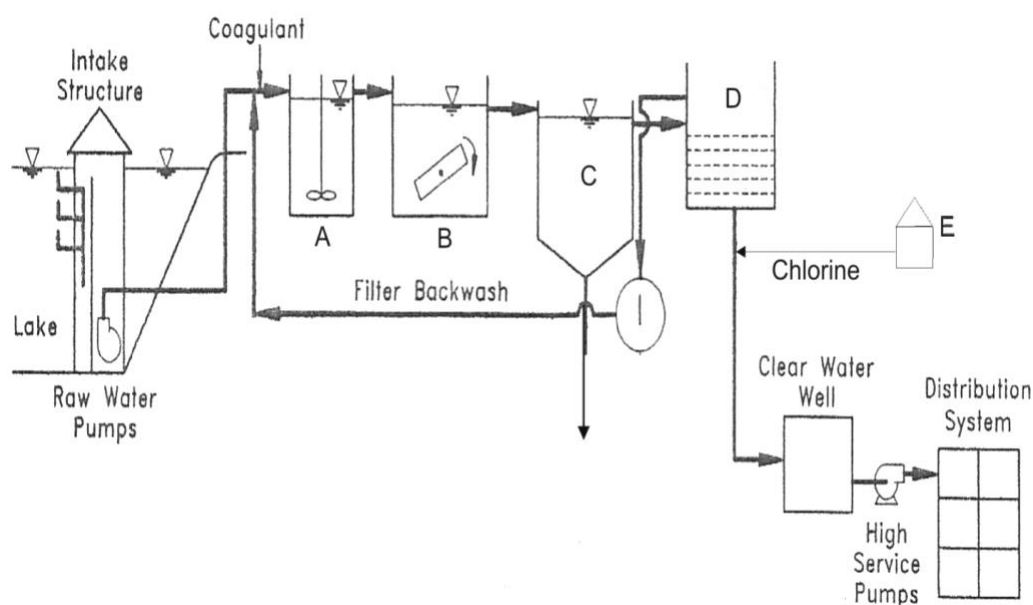

Figure 2.4 A conventional water treatment plant treating surface water.
 A=Coagulation, B = Flocculation, C = Sedimentation, D = Filtration, E = Chlorination

2.7.1 Coagulation and Flocculation

These processes are used to remove turbidity, color, algae and other microorganisms from water surface. The addition of a chemical coagulant to the water causes precipitate formation which entraps these impurities. Aluminum and iron can also be removed under suitable conditions. The floc that forms is separated from the treated water by sedimentation and filtration process. The most common coagulants used are aluminium sulphate and ferric sulphate. These coagulants are dosed into the water depending on the quality of the raw water. This is done near the inlet and where there is high turbulence. The water is allowed to flocculate and then passed into a sedimentation tank.

The advantages of coagulation is that it reduces the time required to settle out suspended solids and effective in removing fine particles that would be very difficult to remove. It is also very effective in removing bacteria, protozoa and viruses. Disadvantages of using coagulants for treatment are the high cost, need for accurate dosing, though mixing and frequent monitoring. The efficiency of the coagulation process depends on the raw water properties, coagulant used, operation factors including mixing conditions, coagulant dose, pH value and the temperature.

2.7.2 Sedimentation

Sedimentation is used to reduce turbidity and solids that are in suspension. Sedimentation tanks are designed to reduce the velocity of flow of the water for it to permit suspended solids to settle under gravity. Without the help of coagulation, only the large particles will be removed and due to the length of time required the system requires a storage tank balance the peaks and troughs in demand. The tanks are usually rectangular with width to length ratio between 1:2 and 1:5. The inlet and outlet must be on the opposite sides. The inlet should be designed in such a way that it distributes the incoming flow as evenly as possible across the tank width and should avoid streaming that would reduce sedimentation efficiency. The outlet should be designed to collect treated water over the entire tank width. The tank should be covered to avoid contamination.

2.7.3 Screening & Filtration

Algae and turbidity are removed from raw water by gravel filters, slow sand, screens, rapid gravity and cartridge filters. Screens are effective for the removal of particulate materials and debris from raw water. The coarse screens will remove weeds and debris while band screen will remove smaller particles including fish and are effective in removing large algae. Microstrainers are used as a pre-treatment to reduce the solid loading before coagulation. A microstrainer may consist of a rotating drum that is fitted with very fine mesh panels. The mesh will ensure that suspended solids -which include algae- are retained. The extent of solids removal will be determined by the mesh size and the nature of the raw water. Water will need subsequent treatment and the screens should only be used as preliminary treatment stage.

2.7.4 Chemical Treatment

2.7.4.1 Control of pH

The pH of water may need to be adjusted in the course of water treatment and before distribution due to the following reasons; to improve the effectiveness and efficiency of disinfection, to facilitate the removal of iron and manganese, to facilitate removal of hardness, for removal of other contaminants including some metals, to ensure the pH value meets the water quality standards and to control corrosion in the distribution system and consumers' installations.

Many raw surface water are slightly acidic and coagulation process further increase acidity. The increase of pH can be achieved by passage of water through a bed of alkaline medium, removal of excess carbon dioxide by aeration and dosing with sodium hydroxide, sodium carbonate or calcium hydroxide. Reduction of pH can be achieved by dosing with suitable acid e.g. sulphuric acid, hydrochloric acid, carbon dioxide and sodium hydrogen sulphate.

2.7.4.2 Disinfection

Contamination by sewage is the greatest danger that is associated with drinking water. This is because the sewage from human source may contain the causative organisms of many diseases. The use of disinfection to kill inactive pathogens and microorganisms is necessary if the raw water has such organisms. Several disinfection methods are used in water treatment process. Disinfection with chlorine is the most widely used method for large water supplies. Ultraviolet irradiation is most used in private water supply plants. Chlorine dissolves in water to form hypochlorous acid and hypochlorite ions. The total concentration of chlorine, hypochlorous acid and hypochlorite ions is always referred to as the free available chlorine. The effectiveness of chlorine for disinfection depends on the form of chlorine, the contact time and the concentration. Hypochlorous acid is the more powerful disinfectant than hypochlorite ion. The World Health Organization recommends that for the effective disinfection of drinking water, the pH should be less than 8.0 and the contact time greater than 30 minutes. This results in a free chlorine residual of 0.2 to 0.5mg/l.

2.8 Methods of Impact Analysis

Scientific research is in many cases evaluated on the basis of the relevance to the study area, the depth of intellectual contribution, as well as the selection, treatment and investigation of the subject. It is also expected to be credible, valid, reliable and generalized. The extent to which any study meets these requirements depends greatly on the part of the methodological approach used. (Silverman, 2007). An objective and analytical approach is therefore very important.

Lakwo (2006) describes impact analysis as an investigation into changes, with a keen focus on the changed variables, its causes including recognizable linkages between a particular intervention and the change itself. He uses a combination of qualitative, quantitative and participatory methods in assessing the impact of microfinance on women empowerment in

Uganda. Another study, Ngorima *et al* (2008) also used a similar combination of methodology to study the gender perspectives in rural health, water and sanitation and poverty in South Africa. In the study, they provided an analysis of the types of methods typically used in impact analysis studies. They showed that, notwithstanding the varying potential and limitation of individual methods, a well-balanced blend of quantitative, qualitative and participatory methods in impact assessment has the capacity of enhancing the quality of the study. As discussed, studies done on impact of improved water supply on education, women empowerment and health always employ these methods in their enquiries. Structured interviews, focused group discussion and an in depth examination of statistical data are especially applicable to research in communities.

CHAPTER THREE: METHODOLOGY

3.1 Introduction

This chapter presents the characteristics of the study area in terms of location, population, climatic conditions and water supply and sanitation facilities available in Gumbo. Materials and methods used in this study is also discussed. These are categorized into sampling design, data collection and data analysis methods used.

3.2 Description of the Study Area

Juba town is the capital city of South Sudan and is situated on the White Nile which is a major transboundary river in Africa. It also serves as the capital of Jubek State which is one of the twenty eight states in South Sudan (Figure 3.1). It covers an area of about 336 km² and has a population of 492,970 (UNICEF, 2018). The area has a tropical wet and dry climate and lies near the equator. The temperatures of the area are hot all year around with maximum temperatures reaching 38 degrees Celsius. The annual total precipitation is nearly 1000 mm. Gumbo is an area located in Juba and the research was mainly focus on a water treatment plant built by Oxfam in the area.

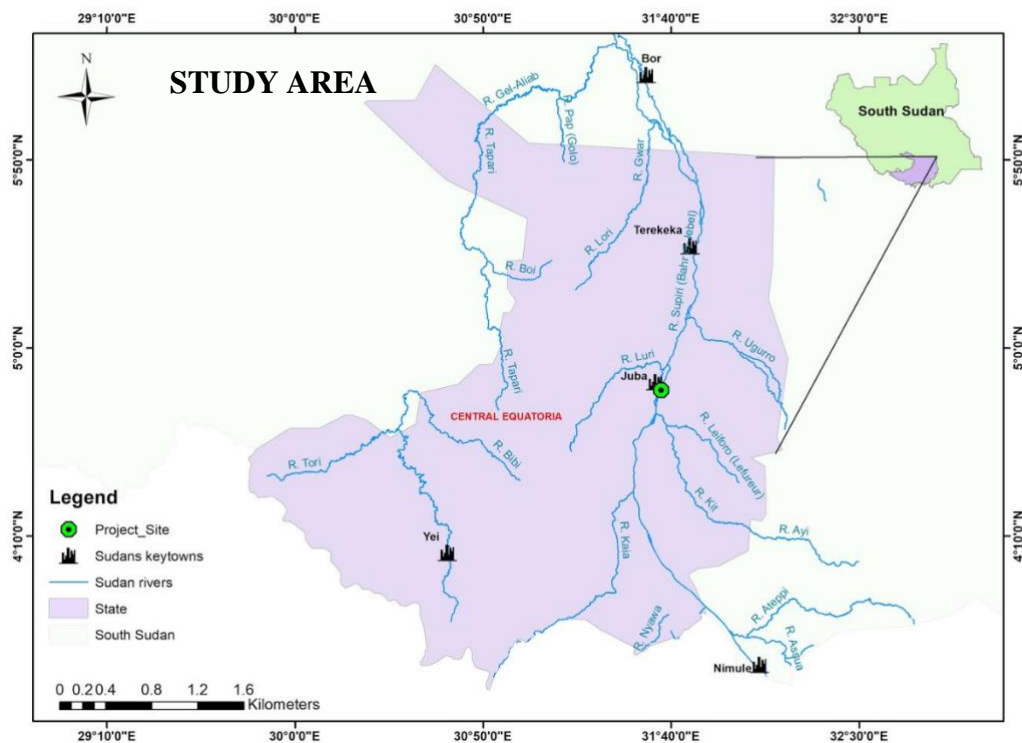

FIGURE 3.1; Map of the study area

3.3 Methodology

There are two main types of methods of carrying out research. The first is positivist paradigm that employs quantitative data collection which includes the structured questionnaires (Aliyu et al, 2014). The other type is the interpretivists that believes that only way to interpret the world is through the mind and therefore uses qualitative data in research. Quantitative research mainly focuses on quantifiable data in terms of numbers and measures that can be analyzed statistically, while the qualitative gives more emphasis on the qualities of entities and on processes and meanings that are not experimentally examined or measured in terms of quantity, amount, intensity or frequency.

This research employed both the quantitative and qualitative approaches so that the two can complement each other in collecting data which was used to describe the livelihood improvement as a result of water supply and sanitation interventions done by Oxfam in South Sudan.

3.3.1 Data Collection Methods and Instruments

Several techniques were used to collect the required information which included; Document/Literature review, household survey questionnaire, focus group discussions, key informant interviews and observation schedules. To determine the sustainability of the project, secondary data from Oxfam were reviewed and a cost-benefit analysis was performed.

3.3.2 Sampling Strategy

The selection of respondents was done using systematic or simple random sampling. The sample size was calculated using Solvin's Formula to estimate the minimum sample size required to determine the desired result at proposed level of significance.

The formula is:

$$n = N / (1 + N \times e^2)$$

Where:

n = sample size

N = Universal population [total population of the coverage area]

e² = Margin of error

1 = is given as part of the standard formula

This formula was used considering the population of the target area Gumbo at 20,000. This is the population that lives within a radius of 500 m from the water treatment plant. The sample size for the study that was used is 250. The number of samples in the actual study was slightly increased to ensure the attainment of a minimum size. In calculating the sample size, a 95% Confidence Level and 5% Margin of Error was considered. By putting the 5% margin of error in the formula, the confidence level was automatically calculated at 95%.

Data Collection Framework

Area of interest	General Research Questions	Collection Methods	Source Of Info	Lead Person Collecting data
OXFAM Water Projects	(i) What are the water projects done by Oxfam In Juba ? (ii) Where are their locations?	Secondary Data Review	OGB WASH	NM
Girls Education	(i) Are the girls enrolled in school? (ii) Is there improvement in participation in class and punctuality? (iii) Are there less cases of illness in the school? (iv) What reason are given my girls for lateness?	Key Informants Interviews HH Survey	Jossana Primary & Nursery School	NM WASH team and Enumerators.
Waterborne Disease prevalence	(i) What is the incidence of the following diseases over the past 2 years? <ul style="list-style-type: none"> ▪ Cholera ▪ Typhoid ▪ Diarrhea (ii) How many children under the age of 5 have been treated for water related diseases in the past two weeks? (iii) Was is the general trend in these diseases prevalence in 2018?	Key Informant Interviews HH Survey	Gumbo Health Centre Water Users	NM Enumerators
Women Empowerment	(i) Is there time saved in fetching water? (ii) Are there economic activities started by women? (iii) Are women involved in decision making at the WTP? (iv) Are there women in the WPC?	HH Survey Key Informant Interview	Water users Women in the Community	WASH Team and Enumerators NM
Sustainability.	(i) Are there people trained on maintenance of the WTP? (ii) Is the WTP revenue able to pay for its maintenance? (iii) Is the WPC able to buy spare parts? (iv) Is the technology used understood by the locals?	FGDs Review of Secondary Data from OGB WASH	WPC	NM

3.3.3 Data collection

Six (6) research assistants with experience in data collection were recruited and trained on the study content. They were assessed for suitability of the exercise and finally put into teams according to expertise based on handling of qualitative or quantitative data. The aspect of language was put into consideration and as such they were to be able to speak Juba Arabic. The data was collected electronically using an online platform called Mombezi. This helped in synchronizing the data from the tablets (Mobile devices) to a main computer that was used to put the data together. The data collection exercise lasted for six days. The data was later downloaded as an excel file and manipulated using SPSS.

Table 3.1 Shows A Typical Entry Sheet

	Year				
		2015	2016	2017	2018
Details					
Cases of AWD	Cholera				
	Diarrheal				
Girls school enrollment	Primary				
	Nursery				

3.3.4 Data Analysis

Quantitative data entry into the analysis software

Data from the questionnaire was manipulated using the Statistical Package for Social Sciences (SPSS). Single transfer coding, was used for the questionnaires. Each column in the data view window represented a variable in the data. Labelling and the kind of data that was to be entered in each column was defined. Each row in the data view window represented a record. Data cleaning was done manually.

3.3.5 Frequency distributions and graphical displays

Frequency distributions were done to analyze the data. This is counting the frequency or the number of times that certain occurrence had happened and presenting the information on a graph or in a table. Robinson (2002) suggests that this makes data easily and quickly understood by a large range of audience.

3.3.6 Summary Statistics

There are a number of ways of representing important aspect of the data set by a single number. This was done by describing the level of distribution of the data using measures of central tendency. Three measures of central tendency were used in this research; namely the mean, mode and median. The mean was obtained by adding all the scores together and dividing by the number of those given scores. The median is the central value when all the scores are arranged in order of size and the mode is the most frequently occurring value.

3.3.7 Analyzing relationships between two variables

Relationships between two variables were analyzed through cross tabulation. Data was presented using a contingency table which was produced by SPSS.

3.3.8 Testing of the Research Hypotheses

In this study research hypotheses will be tested at the significance level of 5%. The study will use chi-square to test the research hypotheses. The choice of chi-square was based on the nature of the data collected since the variables were measured on a binary scale. The formula of the chi-square used was as follows;

$$\chi^2_c = \sum \frac{(O_i - E_i)^2}{E_i}$$

Where;

c are the degrees of freedom.

O is observed value

E is your expected value

Chi-square test is a nonparametric test used for two specific purpose: (a) to test the hypothesis of no association between two or more groups, population or criteria (i.e. to check independence between two variables); (b) and to test how likely the observed distribution of data fits with the distribution that is expected (to test the goodness-of-fit). It is used to analyze categorical data.

CHAPTER FOUR: RESULTS AND DISCUSSION

This chapter presents the results that were obtained during the research period. It touches on the data collected from schools, health centers, water treatments plant and the households' survey done in Gumbo community. The results are presented in graphs, pie charts and tables from the statistical analysis done on SPSS.

4.1 Private Water Sector Supply.

There is a dynamic private sector supplying water in Juba that is filling the gap in public service. This is however achieved at high cost and very low quality of water. Water trucking undertaken by the private sector is the main supply of water in the city. There were about 700 registered water tankers in 2017 with an average capacity of 5m³. The tankers have been collecting water from around 9 filling stations in the River Nile. The cost of a 250 litre drum of untreated water averaged at 100 SSP (South Sudanese Pounds).

There are another 20 locations along the river where bicycle vendors get water and deliver it in 20-litres capacity jerry cans. A bicycle can carry up to 10 jerry cans at a time. The water is mainly untreated and is always treated by the households. The water is sold at 5 SSP per jerry can. In 2014, Oxfam managed to set up two filling stations used by bicycle vendors to deliver treated water to households. This was done in an effort to combat cholera outbreak in the region and the stations were handed over to the community for management. Figure 4.1 shows bicycle water vendors on the street of Juba, while Figure 4.2 shows a typical water truck.

The main source of treated water remains the bottle water manufacturing factories. They distribute high quality treated drinking water in small and large bottles and jerry cans to markets and businesses. The treatment processes used include sand filtration, reverse osmosis, ozone and UV.



Figure 4.1 Showing bicycle vendors supplying water sin Gumbo



Figure 4.2: showing water truck used for supplying water in Juba.

4.2 Objective One: Characterize WASH Projects done by Oxfam in Juba

Oxfam has done a number of projects in Juba town. The projects can be classified as software and hardware. Software project are Water and Sanitation programmes that don't involve physical building of structures. They include hygiene promotion in the community, cholera preparedness and mitigation projects, WASH in schools and trainings of communities. The hardware projects on the other hand refer to projects that involve building of physical structures. These structures include; boreholes and Gumbo water treatment plant. This research work focused on the hardware programs since it mainly deals with Oxfam water supply projects.

4.2.1 Water Supply Infrastructure in Gumbo area

Table 4.1 below shows all the water facilities in Gumbo area that were identified.

#	Payam	Boma	Location	Description	Human Usage?	Livestock usage?	Status	Remarks
1	Rajaf	Gumbo	Gumbo Adodi	Rehabilitated Hand pump	Yes	No	In use	The queue is high
2	Rajaf	Gumbo	Gumbo Bome	Hand Drilled pump by Unknown Company	Yes	No	In use	It take 30 minutes to one hour pumping without water coming out and also in dry season water dries up in the BH
3	Rajaf	Gumbo	Hai Ongolwa	Hand Drilled pump by Unknown Company	Yes	No	In use	
4	Rajaf	Gumbo	Market Area	Rehabilitated from solarized BH to Hand pump by SUFEM	Yes	No	In use	Initially the water point was a solarized BH with the storage tank of capacity of 10,000 litres but due to insecurity of the solar panel, SUFEM decided to take away the panel and changed it to hand pump.
5	Rajaf	Gumbo	Gumbo 1 N&P School	Hand drilled pump by NWERO	Yes	No	In use	

6	Rajaf	Gumbo	Gumbo 111 Basic school	Hand Drilled Unknown Company pump by	No	Yes	Not in use	The water is brownish and smelly hence the waterpoint is near and at the lowest side of the latrine therefore the community and the school at large are not using the water.
7	Rajaf	Gumbo	Gumbo PHCC	Hand drilled pump under NSDO	Yes	No	In use	Water is so salty hence cannot be used for drinking, then secondly the handle is very hard to pump water easily.
8	Rajaf	Gumbo	Hela Giarai	Hand Drilled Unknown Company pump by	Yes	No	In use	Water is brownish and smelly in the morning
9	Rajaf	Gumbo	Hela Giarai	Solarized BH and drilled installed by unknown company	Yes	No		
10	Rajaf	Gumbo	Next to Gumbo 3 basic school	Unprotected shallow well dug by the community.	Yes	Yes	In use	This is used by the community because the nearby hand pump produces smelly and brown water.
11	Rajaf	Gumbo	near the bridge	Surface water treatment plant constructed by Oxfam GB	Yes	No	In use	The water point is used in the community.

4.2.2 The Kor Williams South Solarized Borehole

In April 2018, Oxfam handed over a newly built solarized borehole to the community. The community's major source of water used to be a seasonal stream or water from trucks that were quite expensive. An interview with one of the members of the community indicated that they were happy with the quality of water and the reduction in the distance they had to travel to get to the water point. The borehole is operated by the community members and the water is prized. An impact assessment would be done on this borehole at a later time to determine the extent to which the community have benefited from the borehole. Figure 4.3 shows a typical water supply scheme built by OXFAM.



Fig 4.3; Showing a borehole built by Oxfam in Khor Williang community.

4.2.3 The Gumbo Treatment Plant.

This is one of the unique water projects that have been done by Oxfam in Juba. The solar powered treatment plant has a capacity of 300 m³ per day and is located on the banks of the White Nile (Figure 4.4). The study is focused on this project and evaluated its impacts on health of children under the age of five years, girls' education and women empowerment.

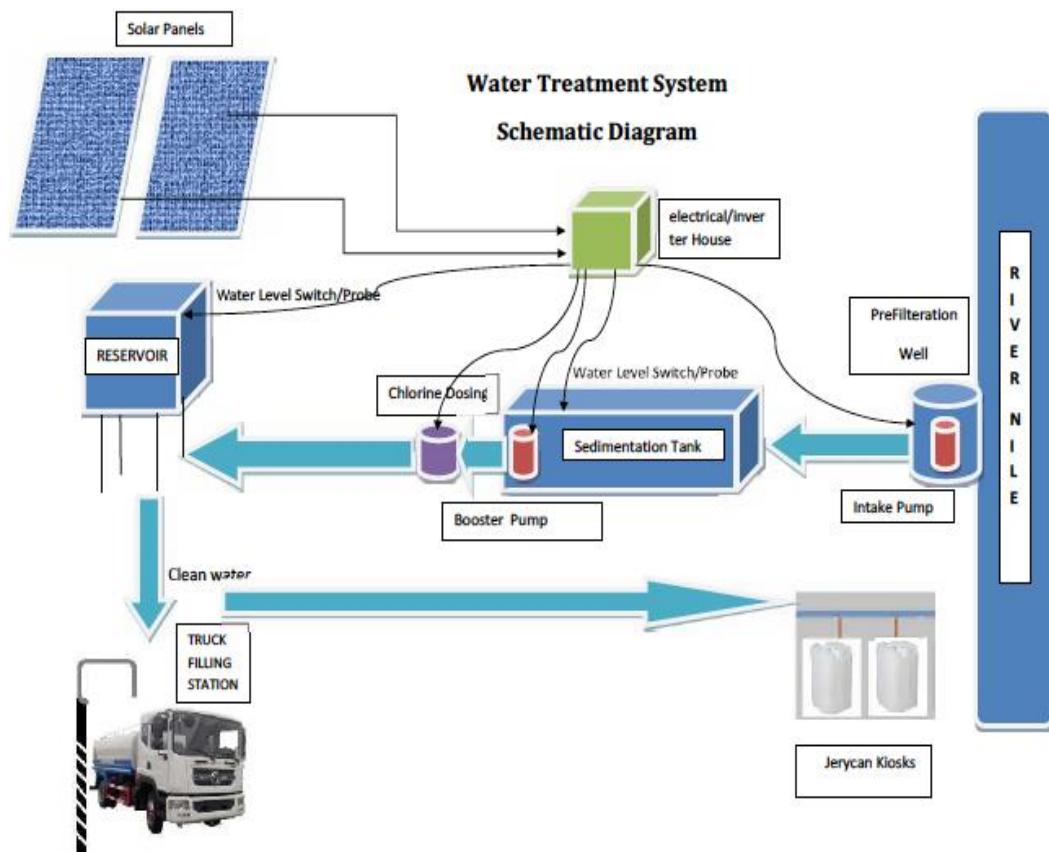

Fig 4.4. Showing the Gumbo treatment plant design.

(Source: Master Document for Gumbo Treatment plant Gumbo 2017)

4.2.3.1 How it works

4.2.3.1.1 Filtration System

This is the first step of the treatment system. It is located aside the Nile River which is the source of raw water. It consists of a filtration well with three filtration layers which includes, a stone boulder with some coarse aggregated outer layer, sand middle layer and a fine filtration layer (Figure 4.5). The raw water from the main source that passes through this layer would be partially filtered. All the debris and large size particles remains outside

the well. The filtered water is then pumped to the sedimentation tank using a GRUNDFOS DWK 80.22 pumps that are designed for heavy duty drainage and dewatering requirements.

Figure 4.5. Showing the Filtration System

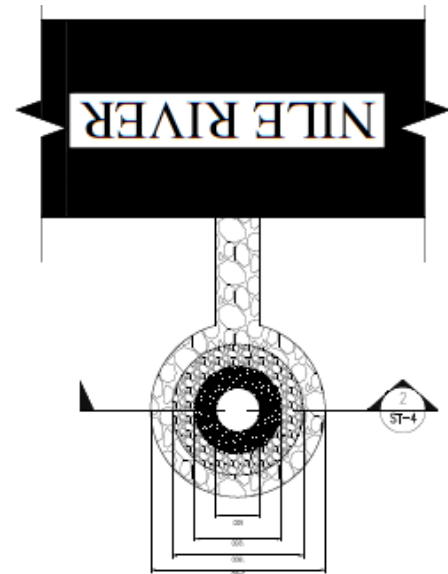

4.2.3.1.2 Sedimentation

The sedimentation tank is the major water treatment component of the project. Its structure has a reinforced concrete shear wall of 150mm thickness all round its periphery and a longitudinal partitions of 200 mm thick shear wall at its center. The shape of the sedimentation tank is a narrow rectangular type with a length to width ratio of L:W 20/3. Since the tank is portioned into two, the actual flow width is 3m. The overall size of the sedimentation tank is 10m x 6m x 3m (Figure 4.6). It is partitioned into five consecutive settlement sections each having a flow passage of size 200 mm x 400mm and 200 mm lower than the preceding section. The tank is a continuous type where there is no interruption in the flow of water during the entire working hours.

4.2.3.1.3 Coagulation

To help in settling dissolved particles, Aluminum Sulphate is added in the first partition where there is enough turbulence cases by the intake pump. The dosing is set at 10 liters per hour. The water is then allowed to flow at a reduced velocity in partitions two, three and four to allow for settling of the particles.

4.2.3.1.4 Chlorination

Chlorine is used as a disinfectant in the plant. This dosing takes place at the final partition of the sedimentation tank and the water is then pumped into the storage tank.

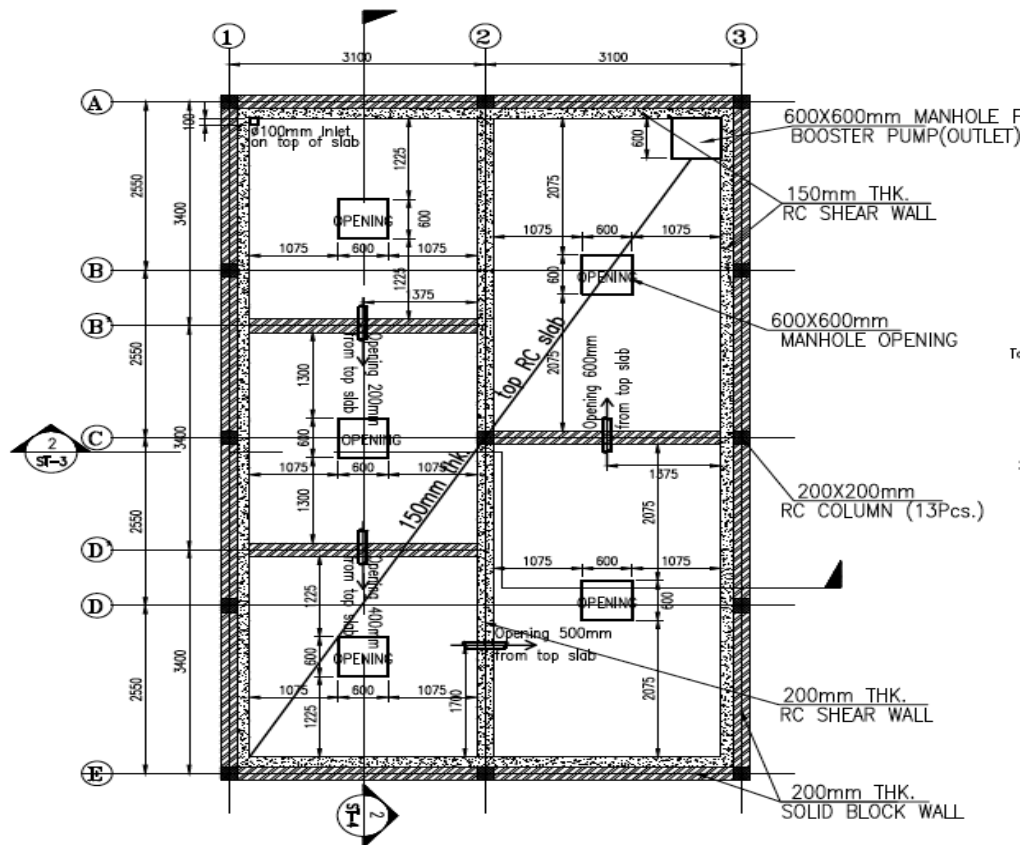

Figure 4.6: Plan view of the sedimentation tank



Figure 4.7 Another section of the treatment plant

4.2.3.1.5 Elevated Water Tank

The main purpose of the elevated water tank is to store the clean water pumped from the outlet section of the sedimentation tank and then distribute it to the public taps and water tank truck filling station by gravity. The tank has a capacity of 136.19 m³ and it is shown in Figure 4.8.



Figure 4.8 Elevated Water Tank

4.2.3.1.6 The Electrical Operation System

The electrical operation system of the water treatment plant is a completely solar power system and it is made up of the following components; the photo voltaic solar modules, the AC solar pump controllers (inverter), the submersible drainage pumps, the Chlorine dosing machine, the desludging machine and the electrical network system. Due to its reliance on solar energy, the plant only operates during the day when there is enough sunlight.

4.2.3.1.7 Water Quality

The measured water quality parameters for the treatment plant include, turbidity, pH and residual chlorine. Measurements were taken during the research period in April and the results are shown in the charts below (Figures 4.9 and 4.10).

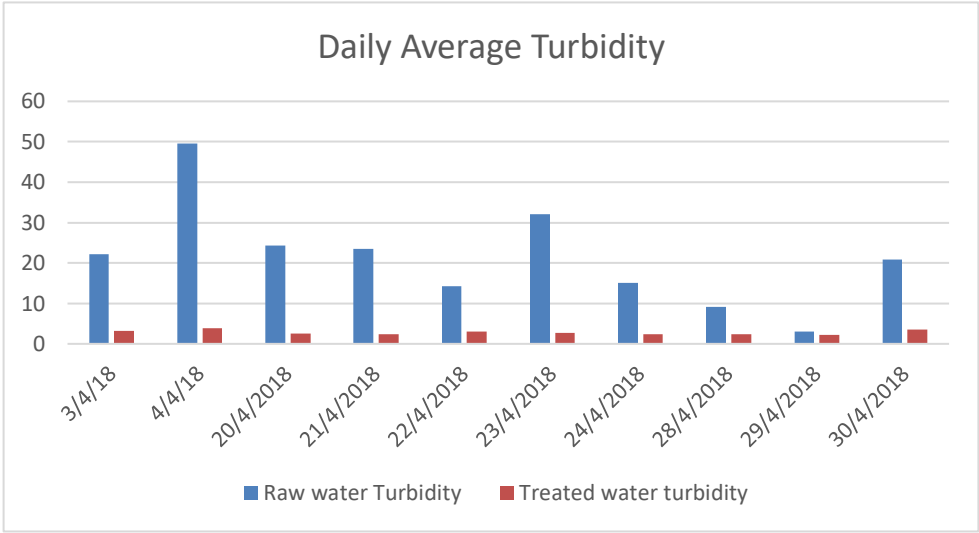
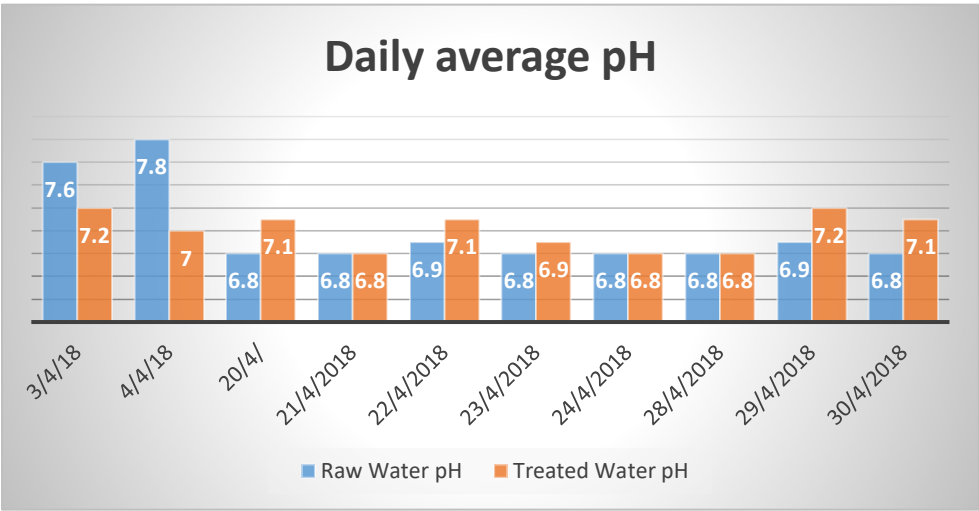
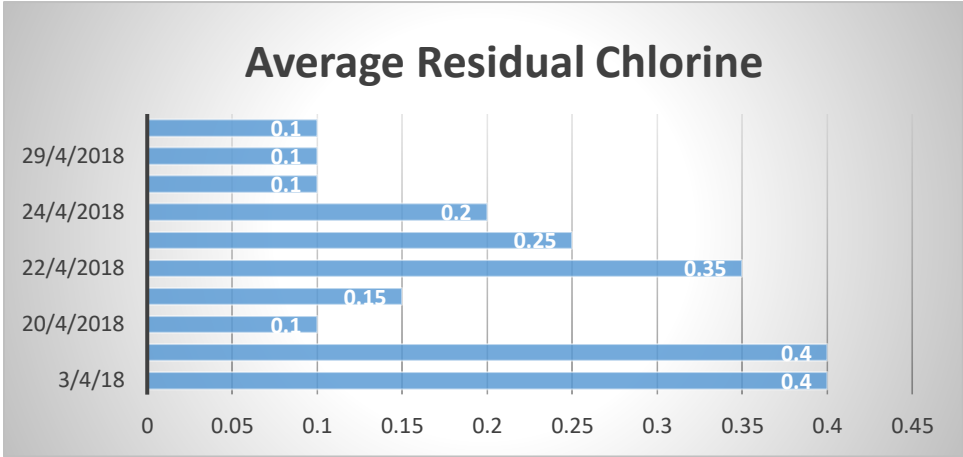

Figure 4.9 Graph Showing the daily measurement for water quality parameters in the month of April 2018.

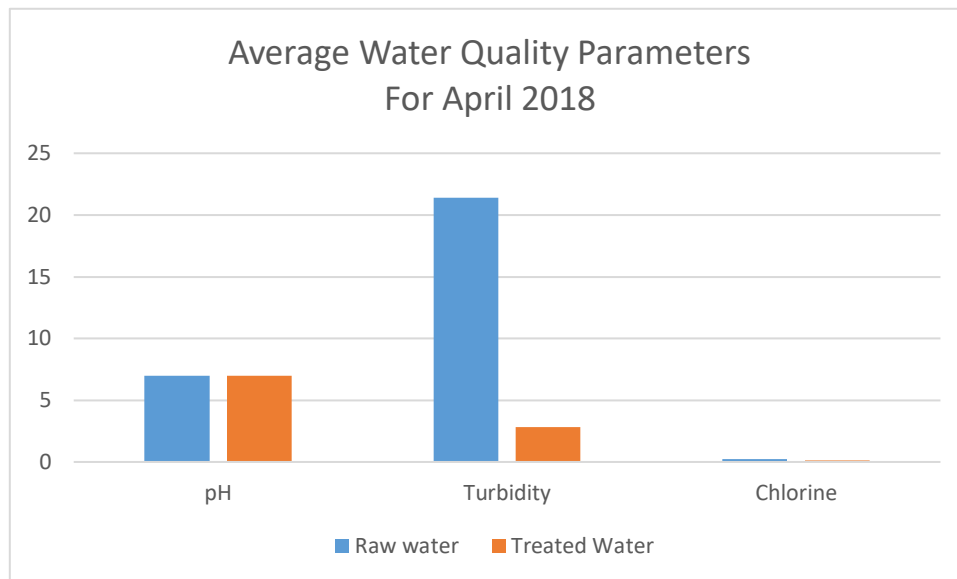

Figure 4.10: Graph Showing the average values for water parameters for month on April 2018

The values measured above meet the basic water quality criteria that are set by the World health Organization. The World Health organization recommends that for the effective disinfection of drinking water, the pH should be less than 8.0 and the contact time greater than 30 minutes. This results in a free chlorine residual of 0.2 to 0.5mg/l. The international standard specifies the highest desirable level and maximum permissible level of turbidity in drinking water is set at 5 and 25 NTU (Nephelometric Turbidity Units) respectively. (Edition, 2011)

4.3 Objective two: Impacts

A household survey was conducted in Gumbo area to determine the impacts of the water treatment plants on the community. The impact assessment was focused on waterborne disease prevalence in children under the age of 5 years, girl child education and women empowerment. The survey was conducted between the period of 17th May and 25th May 2018.

4.3.1 Demographics of the respondents

According to that household survey, a total of 260 households were interviewed and of these 50.38% were male and 49.62% were females (Figure 4.11). It can be inferred that there was gender balance in the interview since both sexes were included with 50% representation.

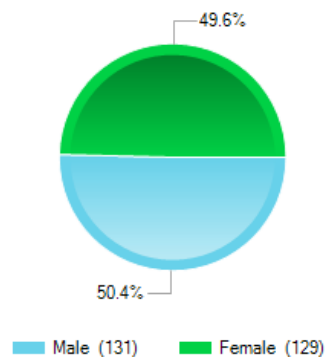

Figure 4.11: A pie chart showing the sex of household interviewed.

Majority of the respondents were adults of the age between 31 and 40 years old representing 46.15%. The age between 11 to 20 years old was also represented having a 1.54%. This shows that the respondents were mainly adults who would give sound responses that are well thought of. No one under the age of ten years was included in the survey as shown in Figure 4.12.

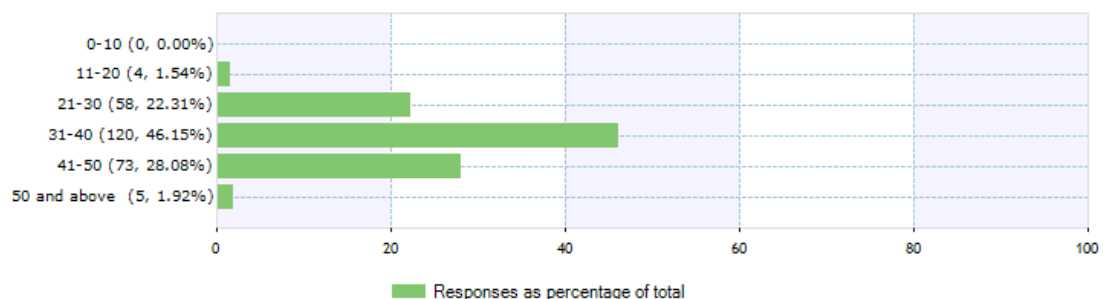

Figure 4.12: Distribution of age of respondents

The data gathered from 260 households indicated that the majority of the households have family members consisting of 5 to 7 people and the minority having between 0-2 people (Figure 4.13). Five to seven people would mean that the household water requirement is high and therefore greater water storage for the family is need including many trips for

fetching the water. The large number also poses a potential risk of communicable diseases as a result of overcrowding in one household. The families are also vulnerable to access of basic WASH facilities as a result of extensive household membership.

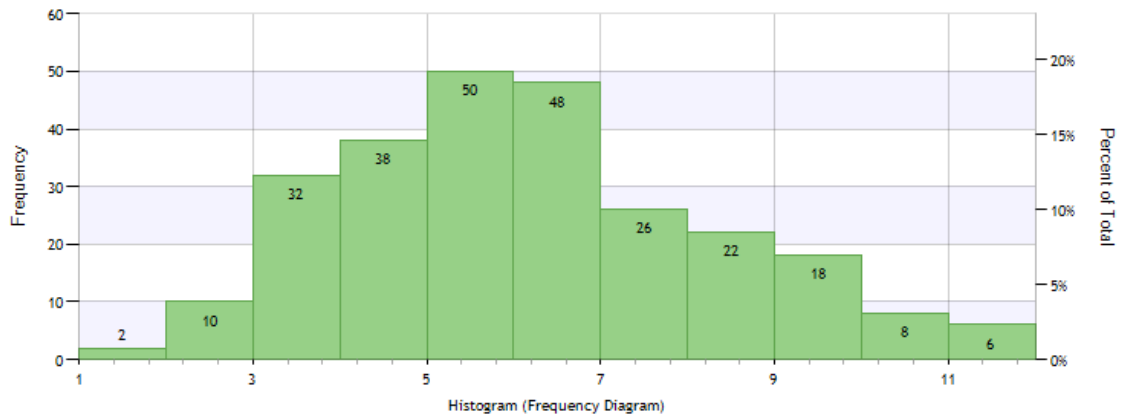
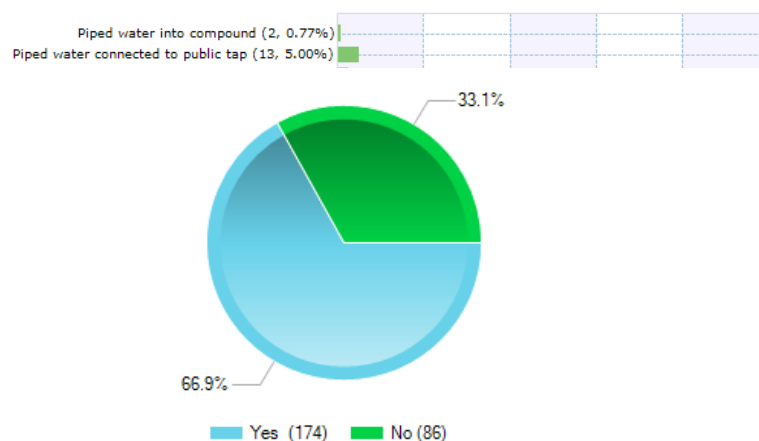

Figure 4.13: Showing the number of people per household in Gumbo

4.3.2 Household Water Supply

The research data from the household survey showed that the three main sources of water used by people in Gumbo are the Gumbo water treatment plant, 66.54%, bicycle vendors (getting their water from the treatment plant) 67.69% and as an alternative 68.08% of the



people use the surface water from river Nile. 16.4% of the respondents use water provided by water trucking (Figure 4.14). These water truck get water from the treatment plant and this increase the number of people using the water from the treatment plant generally.

Figure 4.14: Various sources of water for residents of Gumbo

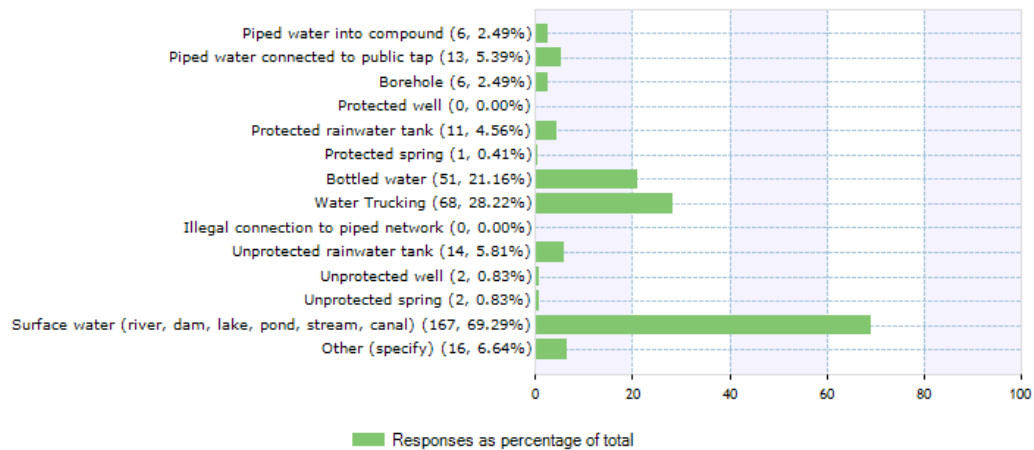

The data from the household survey revealed that 66.92% of the respondents (representing 174 households) had an issue relating to the taste, appearance or smell of the main water source they were using the last 30 days. The other 33.08%, representing 86 households had no issue with either the smell or appearance of the water. When asked what where the issues

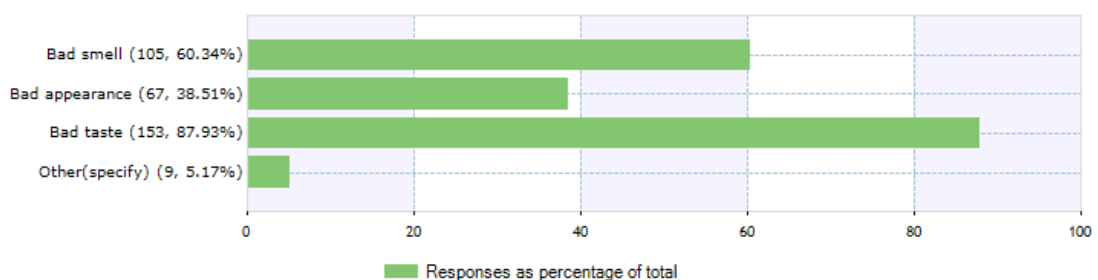

they had, 87.93% said they had an issue with the taste of the water while another 60.34% had an issue with the bad smell (Figure 4.15). The high percentage of the households having an issues with the taste and smell of water can be attributed to Chlorine that is used in water treatment in the plant. The community do not like the smell of chlorine used and several sensitization meeting have been organized to help the Gumbo community know the importance of Chlorine in Water. The sensitization was well attended as participants are seen in Figure 4.16.

Fig 4.15. Showing the various issues the households have with water



Figure 4.16 Picture showing.

The survey also inquired on whether the community used water from other sources of water in the last 30 days. 92.69% of the respondents said yes while 7.31% said no (Figures 4.17).

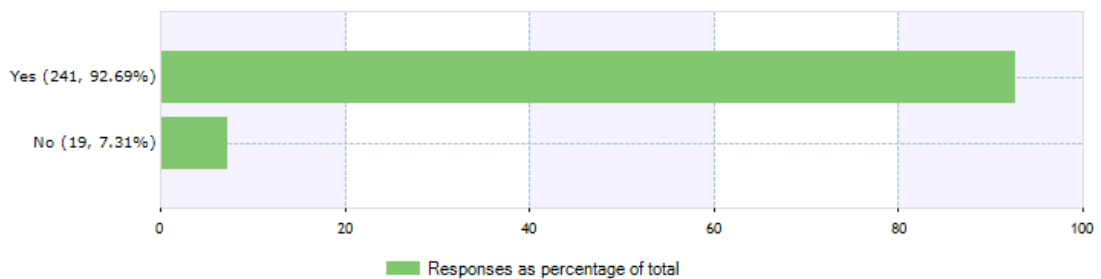

Figure 4.17 Results of respondents on use of other sources of water

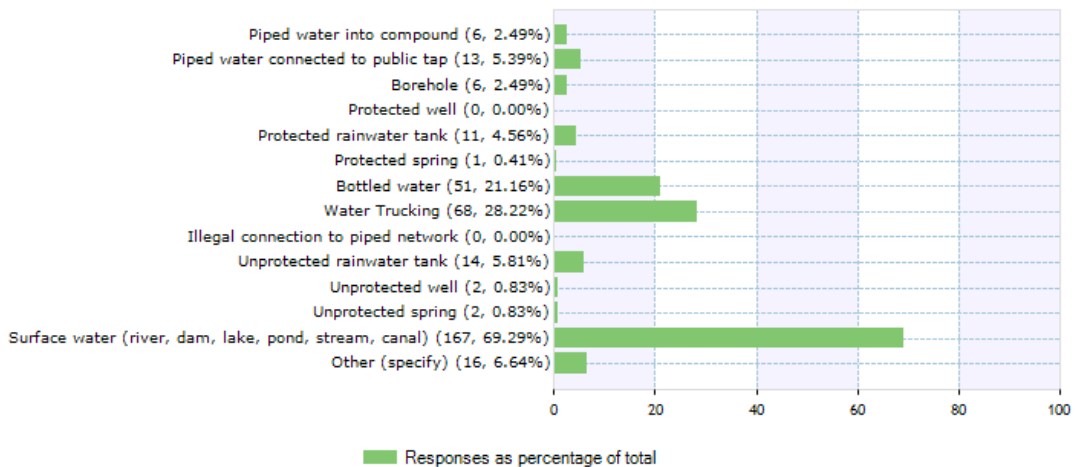

Figure 4.18 : The other sources of water used in Gumbo.

With an interest to know which other sources they used, the survey found out that 69.29% of the household used water from the Surface water which is River Nile according to **Figure 4.18**.

The use of water from River Nile within the last 30 days that the survey was conducted can be attributed to the breakdown of the treatment plant between the 7th and 17th May 2018. There was an electrical fault causes by the inverter and so the intake pump could not get

water into the sedimentation tank. This must have forced people to use the water from the River Nile (Figure 4.19).



Figure 4.19: Photo showing people getting water from the River.

Households were also asked whether they were treating their drinking water. 95% of the respondents said they were treating their water with only 5% saying they did not. The most common method of treating water was use of chlorine with 97.15% followed by boiling having 63.41% and filtering with 54% (Figure 4.20). It is important to note that most households use a combination of the three methods hence had the freedom of choosing all the methods they used.

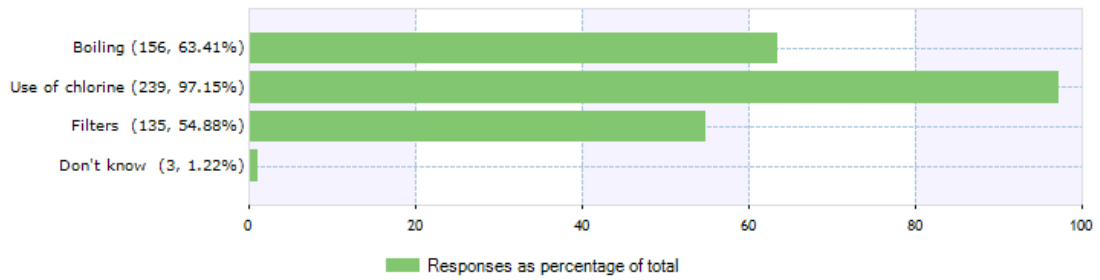

Figure 4.20 Various methods used by households to treat water

The respondents also reported that nearly everyone had enough water for their needs. 30% of those who lacked water had to spend money usually spent on other things to buy water. 20% reduced consumption for hygiene practices, 19% drink water that was usually used for cleaning or other purposes than drinking. 81.54% of the respondents said that the last 30 days prior to the study was representative of the usual habits and consumption of water.

4.3.3 Sanitation

To help the study capture sanitation coverage in the area, respondents were asked if they had a pit latrine in their households. 40% of the respondents said they had one while 60% of the respondents said they didn't have any. this leaves them with an option of open defecation. This poses a great risk on the community when it comes to diseases that are spread through human fecal matter. There are five critical times that people are supposed to wash their hands. The study found out that 93% of the respondents wash their hands after using a latrine, 98% wash their hands before eating, 64% wash their hands after cleaning the babies bottom, 45% wash their hands after touching an animal and another 73% washed their hands before handling food (Figure 4.21).

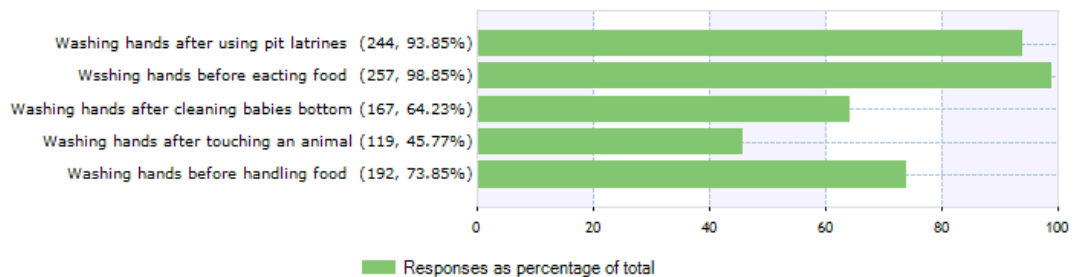

Figure 4.21 Rates of handwashing after various activities

The survey also revealed that 98% of the households know that the use of a pit latrine contributes to the reduction of diarrheal diseases. Other diseases also mentioned included typhoid at 93%, Cholera 91% and dysentery at 76% (Figure 4.22)

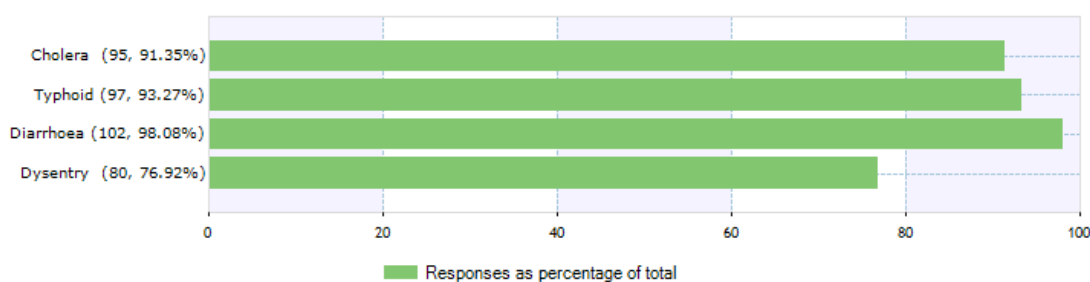

Figure 4.22 Respondents assessment of use of pit latrine in reducing water borne diseases

4.3.4 Impacts on Waterborne diseases

The research found out that there were a number of water borne diseases reported in the area with the last two weeks prior to the commence of the study. 23% of the households interviewed had cases of typhoid reported, 20% said they had a member who had suffered from diarrhea while only 1.92% had cholera (Figure 4.23). 92% of the households interviewed also said none of their children had missed school due to water related disease in the last two weeks.

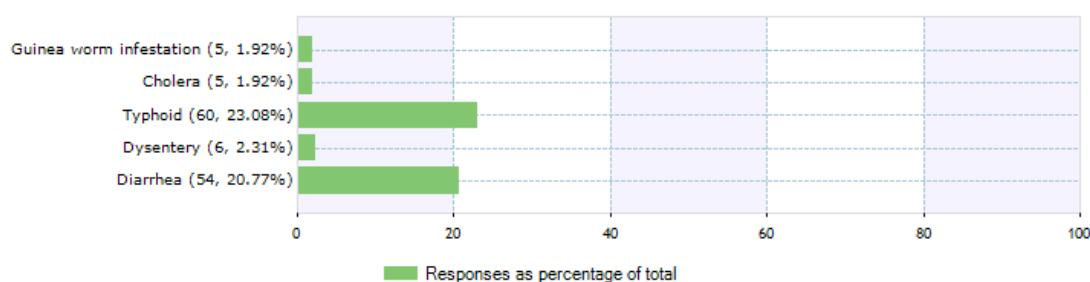

Figure 4.23 Rates of water borne diseases reported in Gumbo

Gumbo community is a cholera prone area. In May 2017 the area had high cases of Cholera according to the interviews conducted with the health workers in the area. They were fascinated at the rate at which the disease has reduced in the area.

The focus of the study was on children under the age of five years. 42% of the households interviewed had children under the age of five years in their family. 77.27% of them said their children had not fallen ill in relation to a water related diseases in the last two weeks prior to the start dates of this study. This is can be attributed to the Gumbo water treatment plant that provides treated water to the community thereby reducing the number of waterborne diseases in the area.

Gumbo community uses different treatment methods whenever a member of the family falls ill. 48% of the households interviewed said they go to the hospital, 5% used self-medication, 44.62% said they don't use any form of treatment while another 5% used other treatment methods not categorized in the study as shown in in Figure 4.24

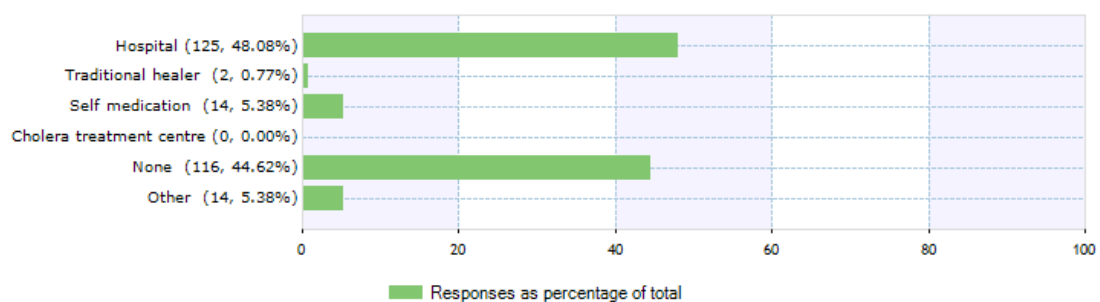

Figure 4.24: Graph showing the treatment methods used in the area.

When asked what was the impact of the sickness on the family. They gave different responses, including; spending a lot of money on medication. Some spent money that was meant for food on treatment. A lot of time was also spent taking care of the sick. The time would have been used in income generation activities. One family noted that a member of their family died due to sickness.

The study also wanted to get knowledge of the respondents on what causes waterborne diseases. 95% of those interviewed said waterborne disease where caused by poor water

quality, 94% said poor hygiene practices while another 69% said badly cooked food (Figure 4.25).

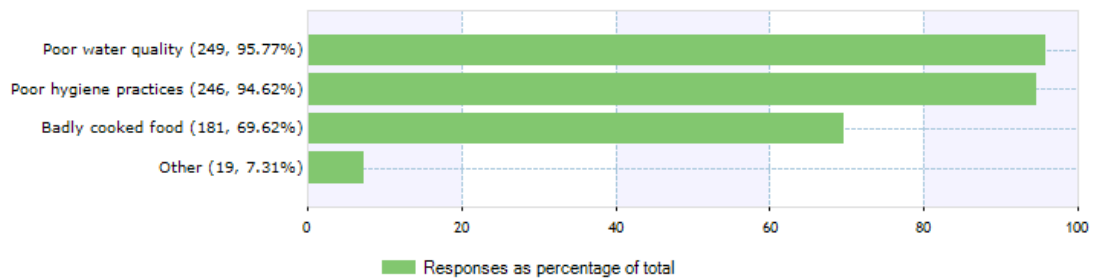

Figure 4.25: Causes of water borne diseases in Gumbo

The study found out that 96% of the respondents had attended a hygiene promotion trained. 98% of those trained said that the training was offered by Oxfam free of charge. The other 2% said they had been trained by community leaders while local authority had not provided any training (Figure 4.26).

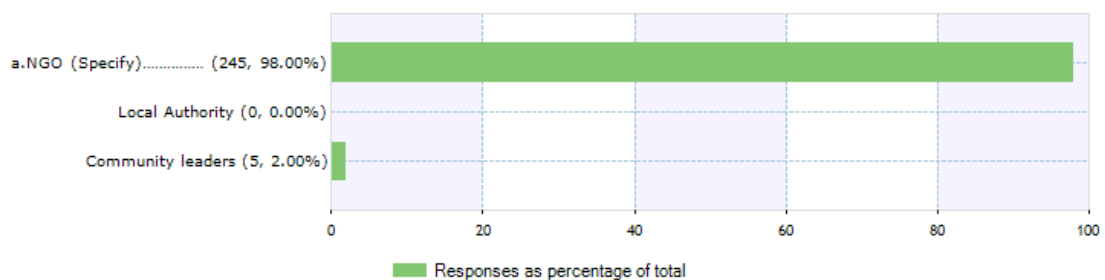

Figure 4.26; Provision of training on hygiene promotion

Key informant interviews were held in two health centers in the Gumbo area to ascertain the health impacts of the water treatment plant on the community when it comes to waterborne diseases. St. Gilbert Clinic is a health center in Gumbo that is managed by an individual and is registered by the local authority. The health worker interviewed in that clinic said that most of his patients come from Gumbo area. In an effort to know the disease trend over the past two years, the interviewer requested to see the health records. The health work said he did not keep records of diseases he treats. He however gave an estimated six (6) cases of typhoid and 5 (five cases of diarrheal diseases in the last two weeks' prior of the commencement of the study.

When asked the number of children under the age of five he has treated, he said only one (1) had visited his facility with diarrheal diseases. He then pointed out that there had been a general reduction of waterborne diseases in the area and that can be attributed to the water treatment plant built by Oxfam in the area.

The other health center visited in the area was Maranata Clinic. It is also located in Gumbo area and it is managed by an individual. The health worker pointed that he had handled twenty-one (21) cases of typhoid in the facility and thirty (30) cases of malaria. Of these cases, 5 typhoid cases and 8 malaria cases were for children under the age of five years. He also said he didn't have record of his patients and could not give a medical record for the interviewer to counter check. He also said there was a general reduction of water related diseases in the area and pointed a figure the water treatment plant that was built by Oxfam in the area.

4.3.5 Impacts on Education

Households were asked the number of children that attend school in their families and a total of 499 was recorded. Of this number 48% were girls and 52% were school going boys as shown in Figure 4.27.

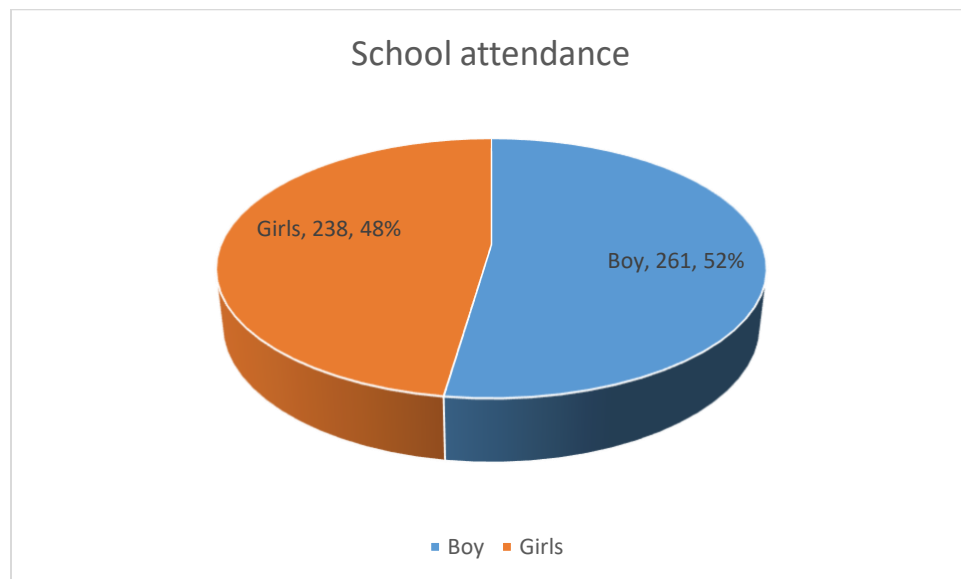

Figure 4.27 School attendance chart showing boys and girls in school

The survey also found out that 352 children had started school after the water treatment plant was built. Of this total 50% were girls and the other 50% were boys (Figure 4.28).

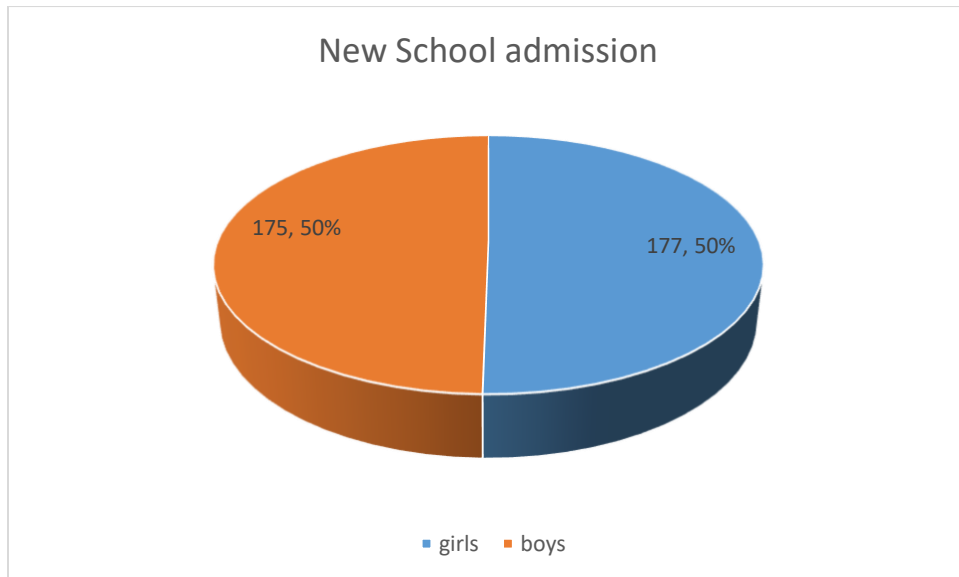

Figure 4.28 New school admission due to improved water to Gumbo

Key informant interviews were held with school principals in two school in Gumbo area in an attempt to ascertain the impacts of the water treatment plant on education in the area. The first school that was visited was Hossana Primary and Nursery School in Gumbo. The study revealed that there was improvement in the health and academic concentration of most students. Most students going to the school were found to be from Gumbo where Oxfam has constructed the water treatment plant.

The graph in Figure 4.29 below shows that there was a general increase in the number of pupils attending school from 2016 to 2018.

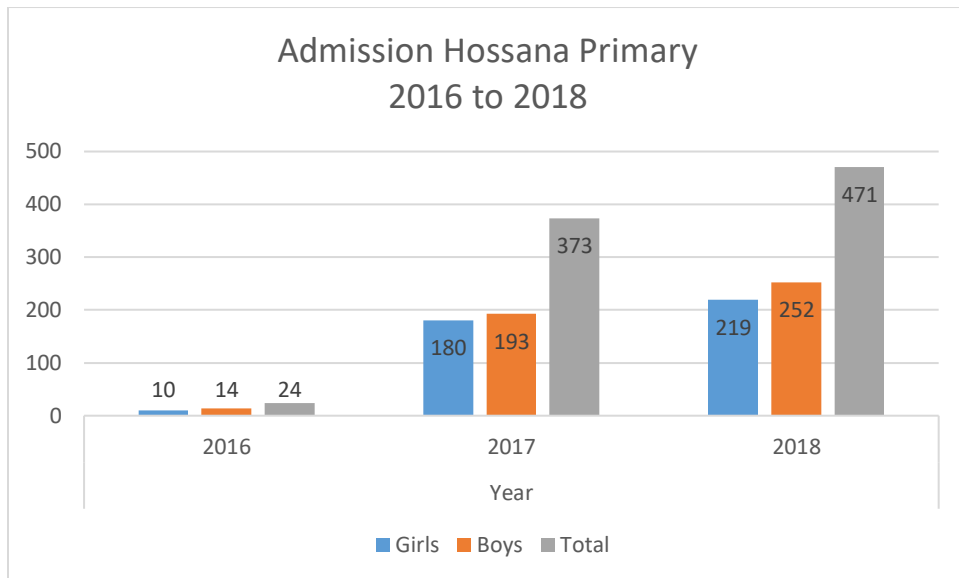
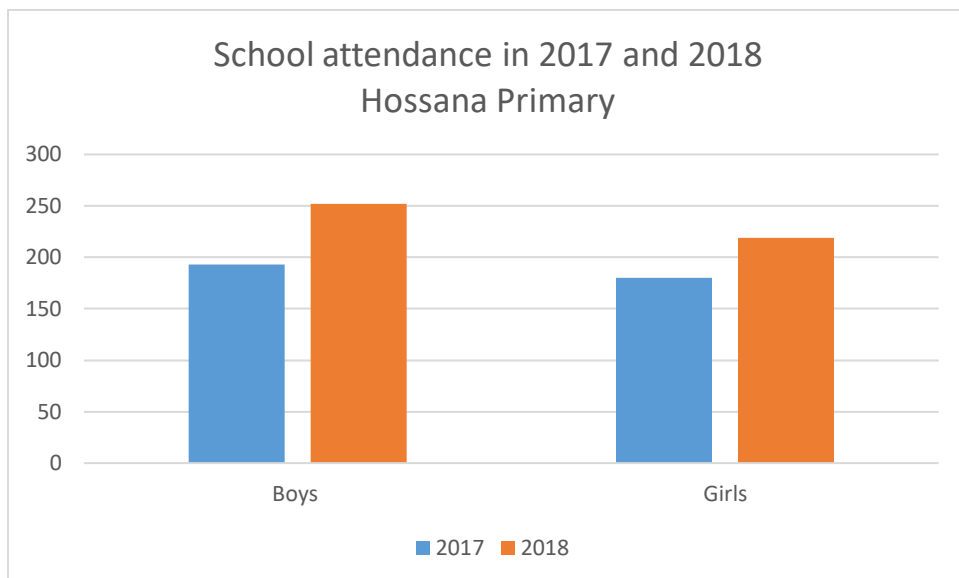

Figure 4.29 Admission and school attendance trends at Hossana Primary school



One of the teachers said there was a relationship between the treatment plant and education in their school. He pointed out that the water used in the school was all from the treatment plant supplied by the bicycle vendors. This has helped the school since students drink treated water as opposed to the situation before where pupils had to drink water from the river Nile directly. He pointed out that there was a general improvement in the health of students since many of them have not fallen ill with a water related disease since the beginning of 2018.

The research found out that there was an improvement in girls’ performance, punctuality and neatness as compared to the years prior to the construction of the water treatment plant. It was also observed that they were more likely to be punctual and participate more in class and performed better than the boys (Table 4.2).

Table 4.2 Attendance record and class performance before and after WTP was provided at Gumbo by OXFAM

	Before the WTP		After WTP	
	Female	Male	Female	Male
Punctuality	3	5	5	4
Lateness	5	4	3	5
Participation in Class	3	5	4	5
Test grades	3	5	5	4

Most students in the schools also gave different reasons for lateness as shown in Table 4.3.

Table 4.3 Reason for lateness to school

		Boys	Girls
Fetching Water	xxx		xxx
Household chores	xxx		xxx
Oversleeping	xxx	xxx	

The second school visited in the area was Gumbo Christian Kindergarten and Basic School. The school is faith based and was built by funds provided by the UKaid. A key informant interview was held with the director of the school.. She pointed out that there was an improvement in pupils’ academic performance especially the girls. She added that the water from the treatment plant was delivered to most households by the bicycle vendors hence freeing the girls from fetching water from the river. This gives them additional time to spend in studying their books.

The school records showed that there was a general increase in the number of pupils in the school as shown in Table 4.4 and the graph below (Figure 4.30).

Table 4.4 School Records in Gumbo Christian Primary School

	2017	2018	Baby Class
girls	206	230	190
boys	244	270	90
total	470	500	250

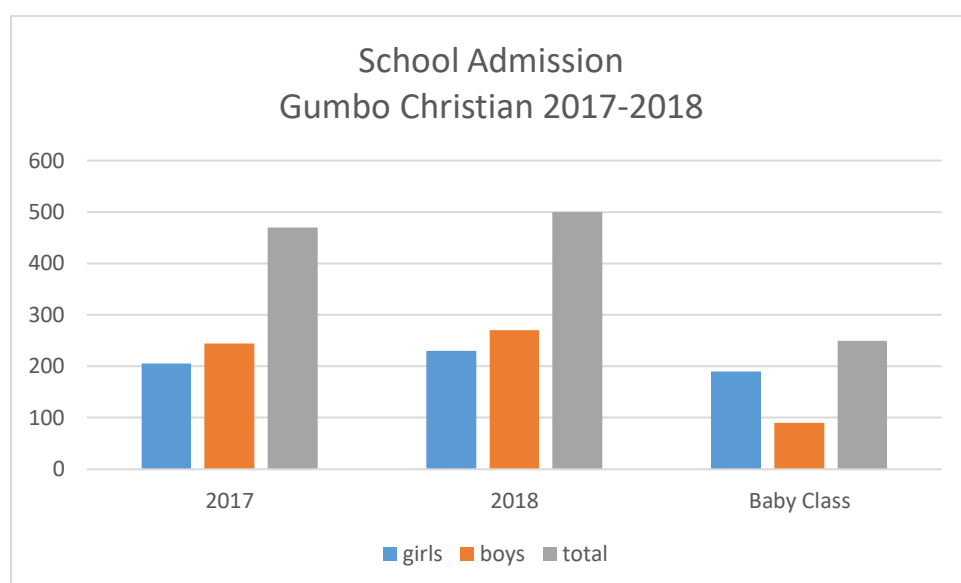

Figure 4.30 Showing school admission in Gumbo Christian School.

The number of pupils in baby class is important since it shows that there are many households taking their young children to school. A total of 50 new students were admitted in the school in 2018.

It was also pointed out that there was an improvement in the girls' academic performance, punctuality and general neatness. She also said there were no water related diseases reported in the school in the last two weeks prior to the study and that all the students were always active and willing to study. The most common reason the students gave for being late for school was walking long distances to school.

4.3.6 Impacts on Women Empowerment and Leadership

The household survey conducted in Gumbo revealed that the residents were aware of the water users' management committee that have the task of managing the daily operations of the treatment plant. 92% of the households said they were aware of the committee while 8% did not know of the existence of the committee. The study also noted that households knew of the conflicts that existed at the water point with unwillingness to pay being the most noted at 31.92%. Water users' quarrels had 26%, lack of proper arrangement for fetching water at 19%, poor leadership at 11% and lack of adequate flow at 3% as shown in the Figures 4.31 and 4.33 below.

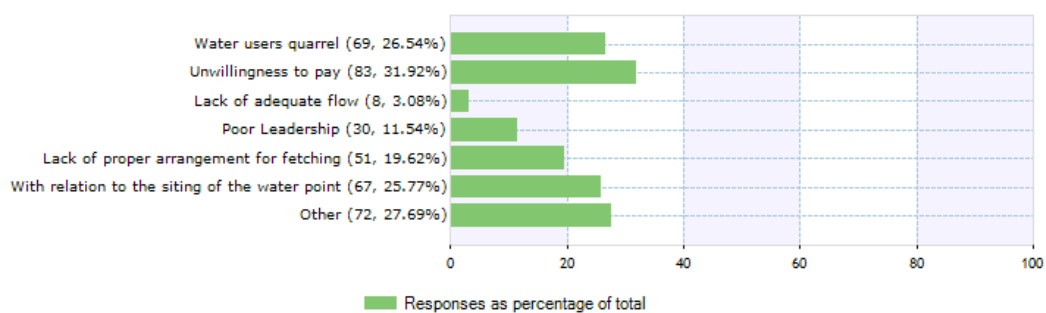

Figure 4.31 Leadership and management issues of the water scheme

The study also noted that the community was aware of the body in control of the water point as the Water management committee with 90% of the respondents confirming. 8% of the respondents did not know who controls the water point while 0.77% said it was the whole community controlling the water point and another 0.77% saying it was Oxfam in control. Also, the structure of the water management committee is shown in Figure 4.32

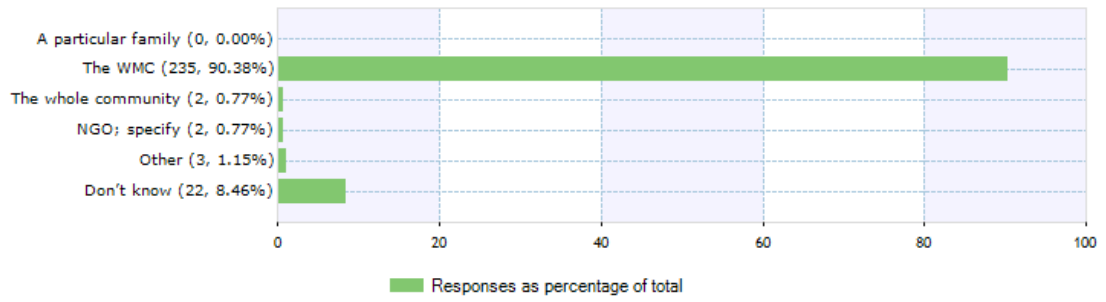
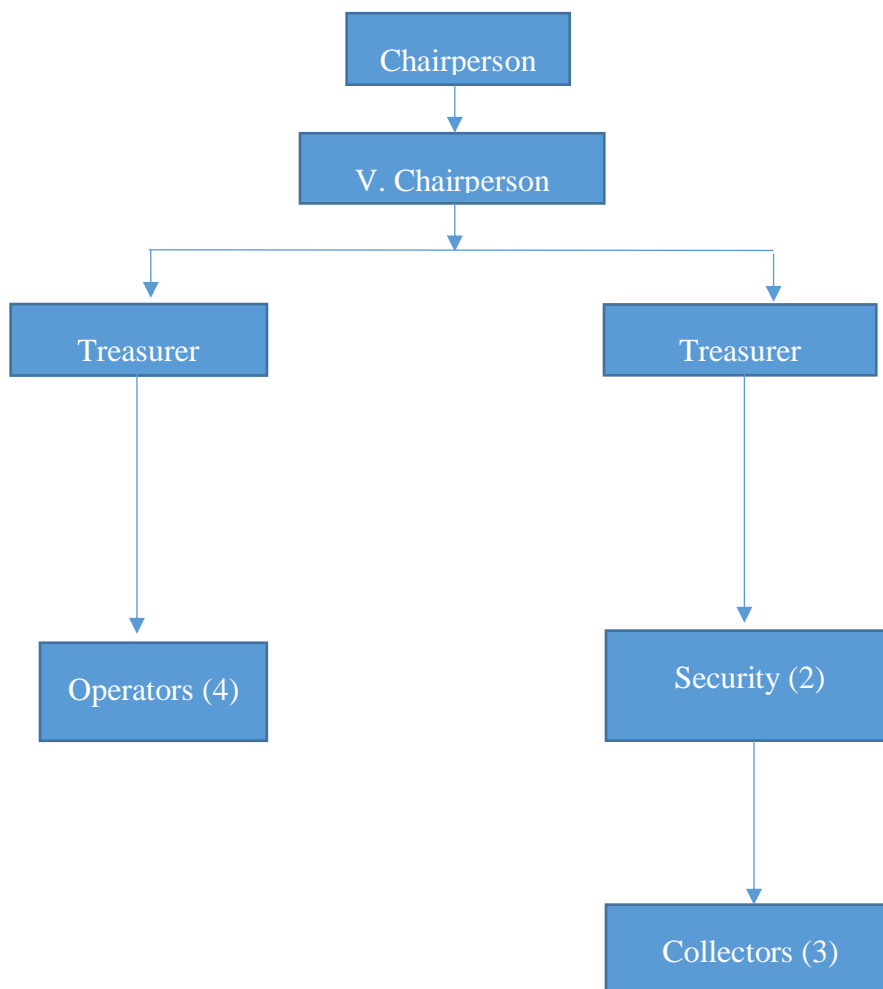

Figure 4.32 Respondents understanding on control of the water scheme

Figure 4.33: Structure of the Water Management Committee



Both women and men are involved in making decisions at the water point as claimed by 74% of the respondents, 15% said it was men only who making the decision while only

1.54% said it was women. 9.23% of the respondents did not know who makes the decision at the water point (Figure 4.34). The results therefore show that women are given a chance to air their views at the water point and this is important since they are the main water users.

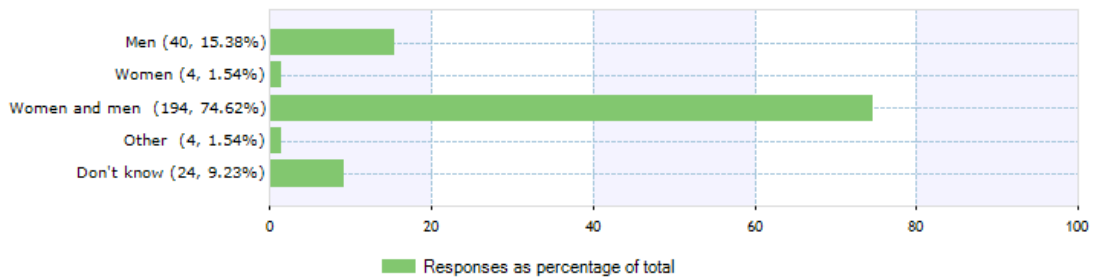

Figure 4.34 Decision making at the water points

The respondents were also asked if they knew the number of women in the Water management committee and the results indicated that the minimum number was zero and the maximum was 6 women. The mean per household response was 2.03 ± 0.02 with a variance of 1.57 and a standard deviation of 1.25. Most of the respondents gave a value of between 3 and 4 as shown in the Figure 4.35 below. A Focused group discussion held with the water management committee revealed that there were 5 women and 8 men in the committee.

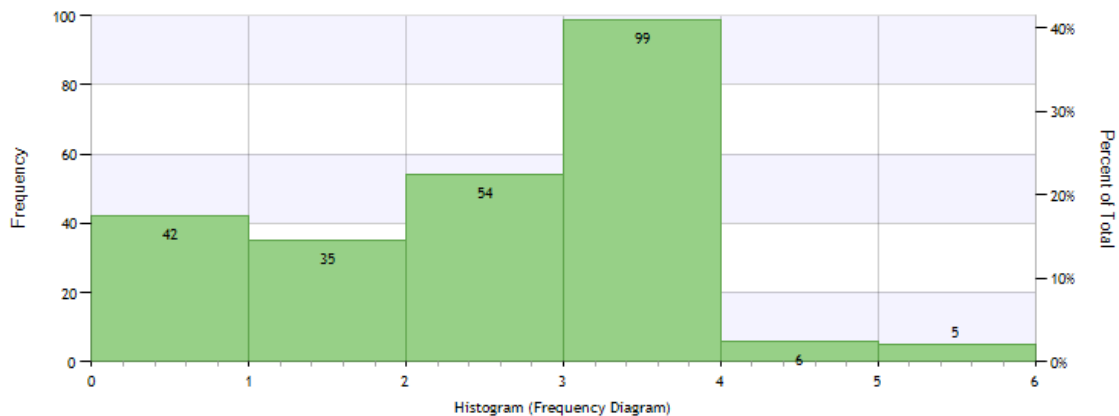

Figure 4.35 Number of women in management committee as claimed by respondents

The survey also noted that 24.23% of the respondents said there were economic activities that were started by women since the water treatment plant was built. 75% of the respondents were not aware of the business and hence said no. Figure 4.36 below shows the various types of businesses that have been started in Gumbo area by women.

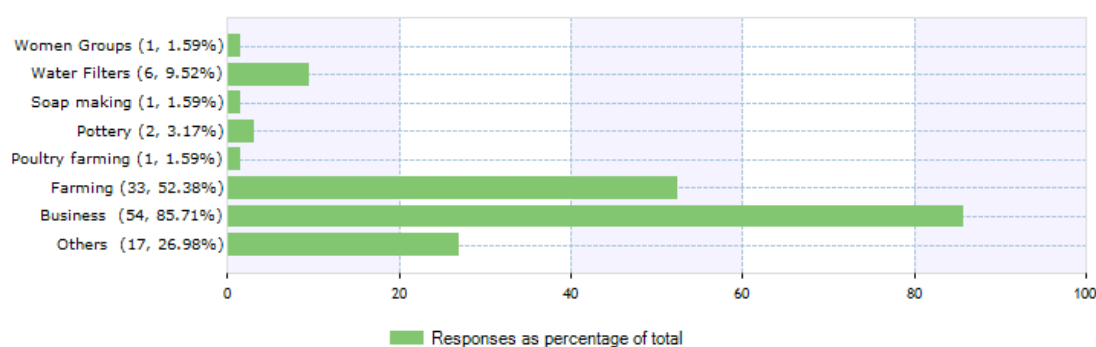

Figure 4.36: Various businesses started by women in Gumbo

A focused group discussion was held with 10 women in Gumbo to get a closer look of the impact the water treatment plant has had on them. The women said they had been able to take a total of 9 (nine) children to school due to the money they get from the business they have been able to start. The treatment plant provided them with treated water hence reduction in house level treatment cost and the saving they get are for school fees and buying more food. They also pointed to the burden they had using water from the river Nile before the treatment plant was built. They had to incur medical costs for treating water related diseases, as the appearance of the water was not good due to high turbidity. The water stains their clothes especially the white one and they also feared going to the river in the evening hours due gender based violence and sexual abuse. They said they did not have a formal women representative at the water committee but knew there were women in the water committee. They said the Gumbo treatment plant had a number of benefits to them including time saving, no extra costs of treating water and a reduction in waterborne diseases.

A lady in the water management committee, said she had been empowered through the training she has received from Oxfam on managing the treatment plant through water

quality testing, chlorine and alum dosing, financial management and maintenance of the plant.

The women also pointed to a number of challenges they are facing as will be discussed in the next chapter.

4.4 Objective Three: Sustainability

A sustainable water project should use a technology that is understood by the locals. The implementing NGO is supposed to train the locals on maintenance and have a management committee that is responsible for daily operation of the plant. Financially the project should generate money that is able to pay for maintenance of the plant and buy spare parts for the plant. The money generated should also be able to pay all the workers and have savings. The plant should be able to operate normally without the involvement of the donor.

A focused group discussion was held by the water management committee to establish if the above mentioned basic requirements for water treatment plant sustainability indicators were met by the Gumbo water treatment plant. The committee said they had received training from Oxfam on how to manage the water treatment plant. The training included water quality tests, financial management and maintenance. They confirmed that the daily collections from the treatment plant are able to pay for the maintenance of the plant if it breaks down and also pay salaries of all the workers in the plant. The committee also affirmed that they understand the technology that was used in the water treatment plant and can do basic maintenance if the plant was to break down. The committee have a plan of upgrading the treatment plant by buying a generator to provide electrical power when the sun is not available in the morning and evening and when it is raining. There are also plans to build a permanent fence around the treatment plant facility and investing the money saved from the treatment plant in other development projects and businesses. The study revealed that the local authority was not involved in a way in the running and management of the water treatment plant.

The funds collected from the treatment plant on a daily basis is taken by the treasurer and deposited every three working days to in the bank. The committee members confirmed that there were no conflicts in the committee and there were no families' related members on the committee. Table 4.5 shows revenue and expenditure profile of the water scheme in the first four months of 2018.

Table 4.5 Revenue & Expenditure per month (Jan-April 2018)

	January	February	March	April
REVENUE (A)	USD	USD	USD	USD
1. Households	228	23	28	34
2. Bicycle Vendors	240	485	480	480
3. Water Tankers	706	756	857	760
Totals	1174	1264	1365	1274
EXPENDITURE				
1. Operations & Minor maintenance	957	912	850	900
2. Capital maintenance (Major Replacement)	153	140	135	145
Total	1110	1052	985	1045
Surplus per month	64	212	380	229

The calculations show that the Gumbo business is financially sustainable. If transparent and effective cash handling procedures are to be followed, the money from water sales would be enough to cover all the monthly expenses and the same time setting aside enough money for major replacements and the remaining amounts can be used for investments in other income generating activities.

4.5 Results on Hypothesis Testing

This section presents the results of hypotheses testing. All the hypotheses in this study were tested using the findings on the chi-square analysis. In order to establish the statistical significance of the hypothesized relationships, Chi-square testing was conducted at 95 percent confidence level ($\alpha=0.05$).

4.5.1 Effect of Oxfam water projects on water borne diseases prevalence among children in Juba

The first hypothesis of the study was; **H0₁** Oxfam water projects do not significantly reduce water borne diseases in children under five years in Juba.

Table 4.6 Cross-tabulation between water borne diseases prevalence and access to water from Oxfam

		Presence of water borne diseases		
		Absence of Waterborne disease	Presence of Waterborne disease	Total
Access To Water from Oxfam projects	Inadequate Access to Water from Oxfam	98	41	139
	Adequate Access to Water from Oxfam	85	36	121
Total		183	77	260

The results presented in Table 4.6 indicated that 77 of the respondents agreed their children had water borne diseases. The results further revealed that 41 out of the 77 that had water borne diseases didn't have access to water from Oxfam projects. Those who access water from the Oxfam plants recorded significant reduction in prevalence of water borne diseases.

Table 4.7 Chi-Square between water borne disease prevalence and access to water from Oxfam

	Value	df	Asymp. Sig. (2-sided)	Exact Sig. (2-sided)	Exact Sig. (1-sided)
Pearson Chi-Square	.002 ^a	1	.964		
Continuity Correction ^b	.000	1	1.000		
Likelihood Ratio	.002	1	.964		
Fisher's Exact Test				1.000	.536
Linear-by-Linear Association	.002	1	.964		
N of Valid Cases	260				

a. 0 cells (0.0%) have expected count less than 5. The minimum expected count is 35.83.

b. Computed only for a 2x2 table

This research used Fisher exact test to test whether there was a significant relationship between access to quality water from Oxfam projects and prevalence of water borne diseases. The Fisher exact test had a significant of 0.536 as shown in Table 4.7 above, which implied insignificant association between Oxfam water projects and water borne diseases. Hence, the study failed to reject the null hypothesis **H₀**: Oxfam water projects do not significantly reduce water borne diseases in children under five years in Juba. The correlation between water borne diseases prevalence and access to water from Oxfam project is shown in Table 4.8.

Table 4.8 Correlation between water borne diseases prevalence and access to water from Oxfam

	Value	Asymp. Std. Error ^a	Approx. T ^b	Approx. Sig.
Interval by Interval Pearson's R	.003	.062	.045	.964 ^c
Ordinal by Ordinal Spearman Correlation	.003	.062	.045	.964 ^c
N of Valid Cases	260			

a. Not assuming the null hypothesis.

b. Using the asymptotic standard error assuming the null hypothesis.

c. Based on normal approximation.

The finding from correlations analysis revealed at Pearson correlation of $r=0.003$ and significant of 0.964 implying weak and positive correlation between access to water and water borne diseases prevalence in Juba. This finding further confirms **H0₁**: Oxfam water projects do not significantly reduce water borne diseases in children under five years in Juba could not be rejected at 5% significance level.

UNICEF (2017) report also revealed the same report found out that 159 million people still collect drinking water directly from surface sources and about 58% are from Sub-Saharan Africa. In terms of sanitation access, there are more than 892 million people worldwide who are practicing open defecation. It is estimated that over 2.3 billion people still lack basic sanitation services. In AfBD (2013), it was observed that the low coverage of improved water supply and sanitation services, in addition to poor hygiene awareness has been the principal cause of water related disease in South Sudan; including cholera, diarrheal and guinea worm. Weak institutional capacity, increase in number of returnees and internally displaced persons continue to exert great pressure on the feeble water supply and sanitation facilities. Water-related illnesses are common in developing countries. When family members get sick, it is the women and girls who are expected to care for them. WHO (2014) estimates that of all the diseases that occur each day, 4.1% are diarrheal in nature. Diarrhea also is responsible for an estimated 1.8 million deaths every year. 87% of the entire burden is pointed at unsafe water supply, hygiene and sanitation. This is mostly concentrated in children who come from developing countries.

4.5.2 Effect of Oxfam water projects on Education for Girls in Juba

The study sought to test whether there was a significant relationship between access to quality water from Oxfam projects and improvement in girl education in Juba. The study tested this association using chi-square and correlation and the findings are presented in Tables 4.9 and 4.11.

H0₂ Oxfam water projects do not significantly improve education for girls in Juba was test at significance level of 5%.

Table 4.9 cross-tabulation between children school attendance and access to water from Oxfam

		Children missing school		
		Continuous School Attendance	Child Missing School	Total
Access To Water from Oxfam projects	Inadequate Access to Water from Oxfam	133	14	147
	Adequate Access to Water from Oxfam	107	6	113
	Total	240	20	260

The finding showed that after the Oxfam projects only 20 children missed school within the region and 14 of them were those that did not access the quality water. These findings implied that Oxfam water projects had an impact on improving education for both girls and boys in the region.

Table 4.10 Chi-Square between children school attendance and access to water from Oxfam

Chi-Square Tests	Value	df	Asymp. Sig. (2-sided)	Exact Sig. (2-sided)	Exact Sig. (1-sided)
Pearson Chi-Square	4.793a	1	0.029		
Continuity Correction	3.826	1	0.05		
Likelihood Ratio	4.866	1	0.027		
Fisher's Exact Test				0.036	0.025
Linear-by-Linear Association	4.775	1	0.029		
N of Valid Cases	260				

The Fisher exact test revealed that there was a significant relationship ($p=0.025$) between Oxfam project and improvement of children education in the region. These finding implied that Oxfam water projects impacted positively and significantly on school attendance within the region and generally on overall education for the children. Availability and access to quality water gave the opportunity to children who were burden by responsibility of water seeking to focus on their education. Similarly, Harvey (2008) identified educational opportunities for girls as a major impact of improved access to clean water due

to the fact that school attendance is increased as a result of reduction in time spent hauling water.

Table 4.11 Correlation between children school attendance and access to water from Oxfam

	Value	Asymp. Std. Error ^a	Approx. T ^b	Approx. Sig.
Interval by Interval Pearson's R	.136	.059	2.201	.029 ^c
Ordinal by Ordinal Spearman Correlation	.136	.059	2.201	.029 ^c
N of Valid Cases	260			

a. Not assuming the null hypothesis.

b. Using the asymptotic standard error assuming the null hypothesis.

c. Based on normal approximation.

The Pearson correlation results further confirm that positive and significant ($r=0.136$, $p=0.029$) impact of Oxfam water projects on children school attendance. Therefore, the null hypothesis that **H₀** Oxfam water projects does not significantly improve education for girls in Juba is rejected at significance level of 5% and the study confirms that Oxfam water project positively and significantly improve education for children in Juba.

The study finding also agree with those of Gross *et al*, (2018) who asserted that efforts should be channeled towards education of the whole community emphasizing on the need for sharing domestic responsibilities. Similarly, Harvey (2008) identified educational opportunities for girls as a major impact of improved access to clean water due to the fact that school attendance is increased as a result of reduction in time spent hauling water. Thakadu *et al*. (2018) research recommended that water projects should incorporate education on the need for practicing good sanitation and also encourage attitude change so as to maximize their health benefits.

4.5.3 Effect of Oxfam Water Projects on Women Empowerment in Juba

The study also sought to test whether Oxfam water projects impacted on women empowerment in Juba. The study tested to find out whether Oxfam water projects increased women participation in economic activities. The null hypothesis of the study was; **H₀**

Oxfam water project does not significantly improve women empowerment in Juba. The results are shown in Tables 4.12 to 4.14.

Table 4.12 cross-tabulation between Women Empowerment and access to water from Oxfam

		Women Empowerment		
			Less Empowered Women (Without Economic Activities)	Empowered Women (With Economic Activities)
Access To Water from Oxfam	Inadequate Access to Water from Oxfam	96	20	116
	Adequate Access to Water from Oxfam	101	43	144
	Total	197	63	260

Results presented in Table 4.12 indicated that 63 women engaged in economic activities which implied that they were economically empowered. Out of the 63 women that were economic empowered, 43 had access of Oxfam water. This is an indication that access to water lead to women empowerment. The study finding also agree with those of Gross *et al*, (2018) who asserted that water supply and related issues are sole responsibility of women.

Table 4.13: Chi-Square between Women Empowerment and access to water from Oxfam

Chi-Square Tests	Value	df	Asymp. Sig. (2-sided)	Exact Sig. (2-sided)	Exact Sig. (1-sided)
Pearson Chi-Square	7.313	1	0.007		
Continuity Correction	6.549	1	0.010		
Likelihood Ratio	7.474	1	0.006		
Fisher's Exact Test				0.009	0.005
Linear-by-Linear Association	7.284	1	0.007		
N of Valid Cases	260				

The results of Fisher exact test revealed a significance level of $p=0.005$ which indicated that there was significant association between access to water and women empowerment. The findings implied that women who had access to water also engaged in economic activities leading to women empowerment. Gross *et al*, (2018) study established that the

amount of time women spends fetching water during the times of severe scarcity always have negative effects on the income levels. The energy that women spend in fetching water had bad effects on their health.

Table 4.14 Correlation between Women Empowerment and access to water from Oxfam

	Value	Asymp. Std. Error ^a	Approx. T ^b	Approx. Sig.
Interval by Interval Pearson's R	.168	.059	2.732	.007 ^c
Ordinal by Ordinal Spearman Correlation	.168	.059	2.732	.007 ^c
N of Valid Cases	260			

a. Not assuming the null hypothesis.

b. Using the asymptotic standard error assuming the null hypothesis.

c. Based on normal approximation.

The Pearson correlation results also confirm that positive and significant ($r=0.168$, $p=0.007$) impact of Oxfam water projects on women empowerment. Therefore, the null hypothesis that **H0₃** Oxfam water project does not significantly improve women empowerment in Juba is rejected at significance level of 5% and the study confirmed that Oxfam water project positively and significantly improve women empowerment in Juba.

According to the ADB (2006) report, less than half (48%) had access to improved water sources for drinking. The survey done in 2010 indicated a 19% increase in access to improved sources of water for drinking purposes. Gross et al, (2018) study established that the amount of time women spends fetching water during the times of severe scarcity always have negative effects on the income levels. The energy that women spend in fetching water had bad effects on their health. The author identified cultural influence as the main reason why husbands in the outskirts areas failed to help their wives with domestic duties. He also stated that this failure was as a result of the low social status of women within the urban outskirts and that it was a situation that mirrored the rural lifestyle of people in Ghana (Gross *et al*, 2018).

CHAPTER FIVE: CONCLUSION AND RECOMMENDATIONS

5.1 Conclusion

From the results presented in the previous chapter it is clear that the Gumbo treatment plant has had an impact on the community. The water supplied by the plant is of good quality as opposed to the River Nile that provides untreated water to the community. The household survey conducted revealed that there has been a reduction of water related disease among children under the age of five years. 23% of the households interviewed had cases of typhoid reported, 20% said they had a member who had suffered from diarrhea while only 1.92% had cholera. This is as opposed to 2017 when a cholera outbreak hit the community during the months of May and June. 92% of the households interviewed also said none of their children had missed school due to water related disease in the last two weeks.

Data collected from the schools also showed that girl child education has improved. Key informant interview with teachers' revealed that girls were concentrating more on their studies, more punctual and had better test grades. The survey also showed that due to the money saved from water treatment and distance reduction by the water provided by bicycle vendor, many households were able to send their children to school.

The women in Gumbo have also been empowered by the treatment plant. Five women are in the water management committee and are employed in the plant. Skill on water quality testing and basic plant maintenance have also been passed to them making them more empowered. The household survey also revealed that many women have started business in the area and have more time to engage in business activities than spending time fetching and treating water.

The study also found out that the project is sustainable since the locals have been trained on maintenance of the treatment plant. The water pricing also makes the plant financially stable as the money from water sales can be used for minor and major repairs, paying the workers of the plant and leaving money for investment in other businesses. The technology used is understood by the local people in Gumbo and the daily operation of the plant takes place without necessarily involving the donor which is Oxfam.

The presence of the water management committee also makes the project sustainable since all decision and responsibilities of management have been left for the community in Gumbo hence they have ownership of the project and therefore are better placed to take care of it.

This study therefore concludes that the Gumbo water treatment plant has had positive impact on waterborne disease reduction in children under the age of five years, it has also help to improve girl child education in the area, has empowered women in the community and is a sustainable project both financially and technologically.

5.2 Challenges and Recommendations

5.2.1 Challenges

The study found the following challenges at the Gumbo treatment plant as listed below.

- i. There was a lot of water wastage at the consumer taps. The bicycle vendors open taps and leave then unattended thereby wasting a lot of treated water from the storage tank.
- ii. The water system relied on sunlight and therefore cannot function when there is heavy rain with cloud cover, neither can it function early in the morning and evening when the sun rays are weak.
- iii. The water management committee members want salaries higher than recommended. High salaries will jeopardize the sustainability of the plant.
- iv. Fights at the water point between households and bicycle vendors. This is on the taps where bicycle vendors do not give households a chance to fetch water.
- v. The community perception on chlorine that is used in the water treatment process is not good. People in Gumbo do not like the taste and smell of the chlorine.
- vi. The system is new to the local and has had a number of breakdowns. When this happens, they go for River Nile water to meet their needs.
- vii. The local authority feels that they are not fully involved in the management of the treatment plant.
- viii. Open defecation next to the treatment plant makes the place aesthetically unattractive.
- ix. The Chlorine and aluminum sulphate dosing system has broken down. This has forced the operators of the plant to use manual dosing system.
- x. The White Nile offers free water and people prefer this as it does not have the smell of chlorine.

5.2.2 Recommendations

In the household survey conducted, several observations and suggestions were made by respondents and various community members. These are listed first followed by other recommendations based on findings from the study.

5.2.2.1 Improvement Strategies and Suggestions from Households

- i. Oxfam should provide women with Jeri cans for fetching water.
- ii. Oxfam should donate wheelbarrows to deserving women to help them carry water, especially those coming from far distances.
- iii. Adjustment of the chlorine levels in the water.
- iv. Construction of more similar plants in the community.
- v. Provide materials for constructing latrines.
- vi. Should ensure the water point works constantly
- vii. Bicycle vendors to reduce the price of water.
- viii. Delegate some taps to be for households use only. When the households are not in the plant, the taps can be used by the bicycle vendors.

5.2.2.2 Improvement Strategies and Suggestions Based on the Study

The following recommendations were identified during the course of the study as listed below.

- i. The management committee and operators should discourage bathing at the intake point next to the river. This is both risky for the aesthetics of the treatment plant and pose potential contamination.
- ii. Oxfam should continue allocating funds to help in the maintenance of the treatment plant since the plant is new and the locals are not ready to fully manage the plant.
- iii. A filtration system should be installed in the treatment plant. This will reduce the cost of desludging the sedimentation plant.
- iv. Due to the fluctuations of the South Sudanese pounds, Oxfam should occasionally change the SSP to USD for the committee. This will help them have a stable currency for their savings.

- v. More sensitization on the importance of chlorine in water treatment should be done in Gumbo area to enable the community know the impact of chlorine in water in killing bacteria and preventing water borne illnesses.
- vi. A health record system should be established by Oxfam to keep track of waterborne diseases trends. This can be done at household level and in the health centers.
- vii. The chlorine and alum dosing systems should be fixed. This will remove the manual dosing system currently used at the plant.
- viii. The storage tank should be inspected for leaking and inner rusting.
- ix. Due to the breakdown of the electrical system experienced during the study that lasted for almost two weeks, an alternative power system should be considered for future operation of the plant.

References

1. Aliyu, A. A., Bello, M. U., Kasim, R., & Martin, D. (2014). Positivist and non-positivist paradigm in social science research: Conflicting paradigms or perfect partners? *Journal of Management and Sustainability*, 4(3), 79.
Available:http://www.who.int/quantifying_ehimpacts/publications/saferwater/en/index.html
2. Bratby, J. (2006). "*Coagulation and flocculation in water and wastewater treatment.*" International Water Association publishing. Alliance House, 12 Caxton Street, London, UK
3. Cheesbrough M. *District laboratory practice in tropical countries part 2.* Cambridge University Press, New York; 2006. ISBN-13 978-0-511-34842-6
4. Edition, F. (2011). Guidelines for drinking-water quality. *WHO chronicle*, 38(4), 104-8.
5. Gender and Water Alliance. (2006). *For Her it's the Big Issue: Putting Women at the Centre of Water Supply, Sanitation and Hygiene Evidence Report.* Dieren: Gender and Water Alliance.
6. Government of South Sudan: (2011–2013) South Sudan Development Plan (SSDP)
7. Government of South Sudan/Ministry of Health: 2006 Sudan Household Health Survey (SHHS 2006).
8. Government of South Sudan/Ministry of Health: 2010 Sudan Household Health Survey (SHHS 2010).
9. Government of Southern Sudan, Southern Sudan Centre for Census Statistics and Evaluation: 2010 Sudan MDG Report
10. Gross, E., Günther, I., & Schipper, Y. (2018). Women Are Walking and Waiting for Water: The Time Value of Public Water Supply. *Economic Development and Cultural Change*, 66(3), 489-517.
11. Harvey, P. (2008). Poverty Reduction Strategies: Opportunities and Threats for Sustainable Rural Water Services in sub-Saharan Africa. *Progress in Development Studies*, 8(1), 115-128.
12. Kararach, G., & Yepes, T. (2017). Water and sanitation in Africa: current status, trends, challenges and opportunities. *Infrastructure in Africa: Lessons for Future Development*, 155.

13. Lakwo, A. (2006). *Microfinance, Rural Livelihoods and Women's Empowerment in Uganda*. Leiden: African Studies Center.
14. Ndiongue, S., Huck, P. M., & Slawson, R. M. (2005). Effects of temperature and biodegradable organic matter on control of biofilms by free chlorine in a model drinking water distribution system. *Water Research*, 39(6), 953-964.
15. Ngorima, E., Nkuna, Z., & Manase, G. (2008). "Addressing Rural Health and Poverty through Water Sanitation and Hygiene: Gender Perspectives" CSIR Biennial Conference, Pretoria Nov. 2008 pg 65
16. Oketch, M. O. (2017). "An assessment of community participation on the sustainability of rural water supply and sanitation projects: A case study of Buikwe town Council in Uganda." Thesis. Makerere University Institutional Repository <http://hdl.handle.net/10570/5505> pg 78-90
17. Oxfam (2015), "Deteriorating Economic Situation and Its effects on Safe and adequate Water Supply in Juba, South Sudan" Pg 10
18. Oxfam (2017). "Master document manual for Construction of Urban Water Facilities Treatment Plant" AG South Sudan Company. Pg 5.
19. Peter, A. (2008). *Taste and odor in drinking water* (Doctoral dissertation, ETH Zurich).
20. A Pruss-Ustun, Bos R, Gore F, Bartram J. 'Safer water, better health: Costs, Benefits and sustainability of interventions to protect and promote health'. World Health Organization, Geneva Switzerland, 2008.
21. Rauniyar, G., Orbeta Jr, A., & Sugiyarto, G. (2011). Impact of water supply and sanitation assistance on human welfare in rural Pakistan. *Journal of development effectiveness*, 3(1), 62-102.
22. Robinson, C., (2002): *Real World Research*. 2nd Edition. Blackwell Publishing, United Kingdom
23. Silverman, D. (2007). *Interpreting Qualitative Data* (3rd ed.). London: Sage.
24. South Sudan National Bureau of Statistics (NBS) South Sudan MDG Status Report 2012
25. Srinivasan, R., & Sorial, G. A. (2011). Treatment of taste and odor causing compounds 2-methyl isoborneol and geosmin in drinking water: A critical review. *Journal of Environmental Sciences*, 23(1), 1-13.

26. Tay, V. (2005). The Child Health Millennium Development Goal: What Water, Sanitation and Hygiene can do in Ghana, WELL Country Note Leicestershire: Loughborough University.
27. Thakadu, O.T., Ngwenya, B.N., Phaladze, N.A., Bolaane, B., Sanitation and hygiene practices among primary school learners in Ngamiland district, Botswana, *Physics and Chemistry of the Earth* (2018), doi: 10.1016/j.pce.2018.02.006.
28. UNESCO-WHO, 2004, "A strategy for Rehabilitation, equalization of opportunities, poverty Reduction and Social Inclusion of People with Disabilities" Geneva, Switzerland. Pg 19
29. UNICEF Kenya Accessed on 17/4/2018 (<https://www.unicef.org/kenya/wes.html>)
30. United Nations Development Program (UNDP). (2006). Human Development Report 2006 -Beyond Scarcity: Power, Poverty and the Global Water Crisis. New York: UNDP.
31. United Nations Organization, Water, Sanitation and Hygiene, December 1st, 2014. United Nations Organization: (<http://goo.gl/b9bIXJ>).
32. United Nations, Department of Economic and Social Affairs, Population Division (2017). World Population Prospects: The 2017 Revision, Key Findings and Advance Tables. Working Paper No. ESA/P/WP/248.
33. Verma, A. K., Dash, R. R., & Bhunia, P. (2012). A review on chemical coagulation/flocculation technologies for removal of colour from textile wastewaters. *Journal of environmental management*, 93(1), 154-168.
34. Vimbayi 2010. "The impact of Rural water supply Programmes In Chivi District, Zimbabwe." Master Thesis, University of Zimbabwe 2010. Pg 45
35. Water Sanitation and Hygiene: Gender Perspectives. Paper presented at the Science real and relevant: 2nd CSIR Biennial Conference, CSIR International Convention Centre, Pretoria.csir.co.za.
36. Weber-Scannell, P. K., & Duffy, L. K. (2007). Effects of total dissolved solids on aquatic organism: a review of literature and recommendation for salmonid species. In *American Journal of Environmental Sciences*.
37. WHO. World Health Report. Geneva: WHO; 2005.
38. World Health Organization (WHO) & United Nations Children's Fund Joint Monitoring Program for Water Supply and Sanitation (UNICEF/JMP). (2008). Progress on Drinking Water and Sanitation: Special Focus on Sanitation. UNICEF - New York, and WHO - Geneva.

39. World Health Organization. (2004). *Guidelines for drinking-water quality: recommendations* (Vol. 1). World Health Organization, Geneva
40. AfBD 2013, “ Annual Report 2013”.

Appendices:

Appendix I: Household (HH) Survey Questionnaire

AN EVALUATION OF IMPACTS AND SUSTAINABILITY OF OXFAM WATER PROJECTS IN JUBA, SOUTH SUDAN

Enumerator:

Date of interview;

1. State Name:

2. Village name;

3. Organization implementing Water Supply activities;
.....

(Please circle the responses.)

A. General

<p>1. Sex: a. Male b. Female</p>	<p>2. Age in years a. 0-10 b. 11-20 c. 21-30 d. 31-40 e. 41-50 f. 50+</p>
<p>3. How many people are there in your household?</p>	<p>4. How many children attend school in your Household? Boys: Girls:.....</p>

B. Water Supply

<p>5. What was the most common water source accessed by people in your community in the last 30 days? (select one) *Clarify that we mean water for household uses</p>	<p>6. Did you have any issue relating to taste, appearance or smell of your main water source in the last 30 days? a. Yes</p>
--	--

<p>Improved</p> <ul style="list-style-type: none"> a. 1.Piped water into compound b. 2.Piped water connected to public tap c. 3.Borehole d. 4.Protected well e. Gumbo Treatment Plant f. 5.Protected rainwater tank g. 6.Protected spring h. Bicycle Vendors i. 7.Bottled water <p>Unimproved</p> <ul style="list-style-type: none"> j. 8.Water Trucking k. 9.Illegal connection to piped network l. 10.Unprotected rainwater tank m. 11.Unprotected well n. 12.Unprotected spring o. 13.Surface water (river, dam, lake, pond, stream, canal) p. 14.Other (specify): 	<p>b. No</p> <p>6.1 If yes, what was/were the issues? Select all that apply</p> <ul style="list-style-type: none"> 1.Bad smell 2.Bad appearance 3.Bad taste 4.Other(specify)
<p>7. Did members of the community use other sources of water in the last 30 days?</p> <ul style="list-style-type: none"> a. Yes b. No 	<p>8. What water sources did they use? (select all that apply)</p> <p>Improved</p> <ul style="list-style-type: none"> a. Piped water into compound b. Piped water connected to public tap c. Borehole d. Protected well e. Protected rainwater tank f. Protected spring g. Bottled water <p>Unimproved</p> <ul style="list-style-type: none"> h. Water Trucking i. Illegal connection to piped network j. Unprotected rainwater tank k. Unprotected well l. Unprotected spring m. Surface water (river, dam, lake, pond, stream, canal) n. Other (specify):

<p>9. Are households in the community treating their drinking water?</p> <ul style="list-style-type: none"> a. Yes, all or most b. Yes but only a few c. No d. I don't know 	<p><i>9.1 If KI answered "a or b" to #9, ask this:</i></p> <p>What is the most common water treatment method?</p> <ul style="list-style-type: none"> a. Use of Chlorine b. Boiling c. Filters d. others
<p>10. Which statement would best describe the access to water for your community, in general, for the last 30 days? (select one)</p> <ul style="list-style-type: none"> a. Everyone/nearly everyone has enough water for their needs (little to no problem) b. Everyone/nearly everyone has problems accessing enough water for their needs (access problem) c. Only people who can afford it have enough water (affordability problem) d. The situation changes all the time: sometimes water access is easy, sometimes it is hard (intermittent access problems) e. There is enough water for some groups (ex: hosts), but not for others (ex: IDPs) (status problem) 	<p><i>10.1 If KI answered b,c or d to 10, ask this:</i></p> <p>What are the ways members of the community cope with the lack of water, if any? (select all that apply but do not prompt answers)</p> <ul style="list-style-type: none"> a. Reduce drinking water consumption b. Reduce water consumption for hygiene practices (bathe less, etc) c. Spend money usually spent on other things to buy water d. Go fetch water to a further water point than the usual one e. Receive water on credit/Borrow water f. Drink water usually used for cleaning or other purposes than drinking g. Other(explain) h. Do not know
<p>11. Were the last 30 days representative of usual habits and consumption?</p> <ul style="list-style-type: none"> a. Yes b. No 	<p>12. How many children in your household have gone to school since the water Plant was installed?</p> <p>Girls:.....Boys:.....</p>

C. Waterborne Diseases

<p>13. Has anyone in your household suffered any of these diseases within the last 2 weeks?</p> <ul style="list-style-type: none"> a. Guinea worm infestation b. Cholera c. Typhoid d. Dysentery e. Diarrhea 	<p>14. Has any of you children missed school due to Water related disease in the last two weeks?</p> <ul style="list-style-type: none"> a. Yes b. No
<p>15. Do you have a child under the age of 5yr?</p> <p>Yes No (Go to 18)</p>	<p>16. Has he/she fallen ill because of water related disease in the last two weeks?</p> <ul style="list-style-type: none"> a. Yes b. No
<p>17. What was the impact of the illness on the household?</p>	<p>18. Please indicate which form of treatment you get when you fall ill:</p> <ul style="list-style-type: none"> a. Hospital b. Traditional healer c. Self-medication d. Cholera Treatment Centre e. None f. Other:
<p>19. Do you know what causes Water diseases?</p> <ul style="list-style-type: none"> a. Poor water quality b. Poor hygiene practices c. Badly cooked food d. Other..... 	<p>20. Have you attended any hygiene promotion train/education:</p> <ul style="list-style-type: none"> a. Yes b. No (Go to 22)
<p>21. Who trained you on Hygiene?</p> <ul style="list-style-type: none"> a. NGO (Specify)..... b. Local Authority c. Community leaders 	

D . Leadership and Women Empowerment

<p>22. Do you have a water management</p>	<p>23. What conflicts exist at the water point?</p>
--	--

<p>committee (WMC)?</p> <p>a. Yes b. No</p>	<p>a. Water users quarrel b. Unwillingness to pay c. Lack of adequate flow d. Poor Leadership e. Lack of proper arrangement for fetching f. With relation to the siting of the water point g. Other.....</p>
<p>24. Who controls the water point?</p> <p>a. A particular family b. The WMC c. The whole community d. NGO; specify:..... e. Other..... f. Don't know</p>	<p>25. Who makes decisions about the water point?</p> <p>a. Men b. Women c. Men and women d. Other..... e. Don't know</p>
<p>26. How many women are there in WMC?</p>	<p>27 . Does the committee for the treatment plant consult other community members on issues regarding the water point?</p> <p>a. Yes b. No c. Don't know</p>
<p>28. Are there economic activities that have been started by women around you since the Water Treatment plant was built?</p> <p>a. YES b. NO (Go to 30)</p>	<p>29. If Yes; Tick the appropriate</p> <p>(i) Women Groups (ii) Water Filters (iii) Soap making (iv) Pottery (v) Poultry farming (vi) Farming. (vii) Business Others:.....</p>
<p>30. What benefits have been brought about by the Water Treatment Plant to women?</p> <p>1. 2. 3. 4. 5.</p>	<p>31. What would you like Oxfam to do to make the water supply better?</p> <p>1. 2. 3. 4.</p>

	5.
--	----

Thank you for your Feedback

Appendix II: Questions for Sustainability (For WMC)- FGD

- i. Are there people trained on maintenance of the GWTP?
- ii. Is the GWTP revenue able to pay for its maintenance?
- iii. Is the WMC able to buy spare parts?
- iv. Is the technology used understood by the locals?
- v. What plans do you have for improving the treatment plant.
- vi. Is the local authority involved in the maintenance?
- vii. How do you manage funds from the Water Treatment Plant
- viii. How many people are related in the WMC?
- ix. What benefits have been brought about by the treatment plant.
- x. What are the main challenges you face?

Appendix III: FGD for Women

- a. What businesses have you started since the GWTP was installed
- b. How many children have you taken to school
- c. Has any of your children fallen sick in the last 2 weeks
- d. What source of water were you using before GWTP?
- e. Was there anything wrong with the water
- f. Do you have a women's representative in the WMC?
- g. How many women are there in the WMC?
- h. What are the benefits that have been brought about by the treatment plant to the women?
- i. What are the main challenges you face?

Appendix IV: Health Centre Questionnaire.

Name of Health Centre:

Type of health Centre:

Location:.....

Respondent:

Purpose

To know the Waterborne disease trends in Gumbo Community

1. Where do your patients come from?

.....
.....
.....

2. What is the incidence of each of the following diseases over the past 2 years? Trends

Disease	Before WTP (2017)	After WTP (2018)
1. Cholera		
2. Typhoid		
3. Diarrhea		
4. Others:		

3. How many children Under the age 5 have you treated for water-related disease in the past 2 weeks

.....
.....
.....

4. Have you observed any other medical conditions associated with water and/or sanitation?

.....
.....
.....
.....

Appendix V: School Teachers Questionnaire

Name of school:

Type of school:

Location:

Respondent:.....Position:.....

PURPOSE

To get teachers' views about school enrollment, attendance and performance patterns of students

in Gumbo community

1. Which villages do your students come from?

.....
.....

2. Have you seen a change in student behavior since the water project started?

They come to school early

They concentrate more

They perform better

3. How many pupils are there in the school.

	2017	2018
--	------	------

Girls		
Boys		
Total		

4. How many new student have you enrolled this year?

.....

5. On a scale of 1 to 5, where 1 is poor and 5 is excellent, how would you rate the academic performance of your students in the following areas before and after the water project:

	Before Water Project					After Water Project														
	Female		Male			Female		Male												
I Punctualit y	1	2	3	4	5	1	2	3	4	5	1	2	3	4	5	1	2	3	4	5
II Lateness	1	2	3	4	5	1	2	3	4	5	1	2	3	4	5	1	2	3	4	5
III Participati on in class	1	2	3	4	5	1	2	3	4	5	1	2	3	4	5	1	2	3	4	5

VI Test grades	1 2 3 4 5	1 2 3 4 5	1 2 3 4 5	1 2 3 4 5

6. Which categories of students are more likely to be punctual now?

- a. Boys
- b. Girls
- c. Those living far away
- d. Other (Please specify)

7. The most common explanation students gave for being late:

Explanation Given	(Tick)	Who Gave	
		Girls	Boys
Fetching water			
Assisting in house chores			
Walking long distances to school			
Sickness			

8. Any other observation you would like to talk about.

.....
.....
.....
.....
.....

Appendix VI :Budget

Item	Unit (number of item)	Cost per unit (\$)	Total
Travel to Kenya	1	1000	1000
Flight ticket to Juba and from Juba. (2 flights)	2		1100
Visa	3	50	150
Insurance	1	150	150
Stationary (Printing, Photocopying, Paper Pens)	1	100	100
Local Travel in South Sudan		10	150
Data analysis Software	1	350	350
Total Costs			3,000